

# Observing with ALMA: A Primer for *Early Science*



[www.almascience.org](http://www.almascience.org)

## User Support:

For further information or to comment on this document, please contact your regional Helpdesk through the ALMA Science Portal at [www.almascience.org](http://www.almascience.org). Helpdesk tickets will be redirected automatically to the nearest ALMA Regional Center at ESO, NAOJ or NRAO.

## Revision History:

---

Version	Date	Editors
1	1 March 2011	Gerald Schieven, James Di Francesco, Doug Johnstone
2	31 March 2011	Gerald Schieven
2.1	5 April 2011	Gerald Schieven, James Di Francesco
2.2	24 May 2011	Gerald Schieven

---

## Contributors

This document was produced by the National Research Council of Canada with the National Radio Astronomy Observatory, with contributions from staff of the European and East Asian ALMA Regional Centers (ARCs).



In publications, please refer to this document as:

**Schieven, G., ed., 2011, Observing with ALMA: A Primer for Early Science, ALMA Doc. 0.1, ver. 2.2**

# Table of Contents

Purpose of this Document	4
A List of Relevant Acronyms	4
What is ALMA?	5
What is Interferometry?	7
What is Early Science?	8
ALMA Early Science Capabilities	9
ALMA Early Science Correlator Modes	9
ALMA Regional Centers (ARCs)	11
Science with ALMA	12
Before You Propose for Early Science	13
Examples of Early Science Observing With ALMA	15
A Survey of Molecular Gas and Dust in Submillimeter Galaxies	16
Mapping a Lensed High Redshift, Gas-Rich Galaxy	18
Molecular Absorption Lines at $z=0.9$	19
Observing a GRB Afterglow (A Target of Opportunity)	20
Imaging CO Gas in a Nearby Starburst Galaxy	21
Chemical and Evolutionary Diversity in a Massive Protostellar Cluster	23
Multi-wavelength Continuum Survey of Protostellar Disks in Ophiuchus	25
Continuum and CO J=3-2 Emission from the Pluto-Charon System	27
Observations and Data Reduction	29
Interferometry Concepts for ALMA: A Glossary of Terms	37
A Few Useful Equations	40
A Summary of “Learn More” Links	41

Figure 1: *Thirteen antennas at the ALMA high site, the AOS (15 May 2011). (Photo courtesy of N. Mizuno)*



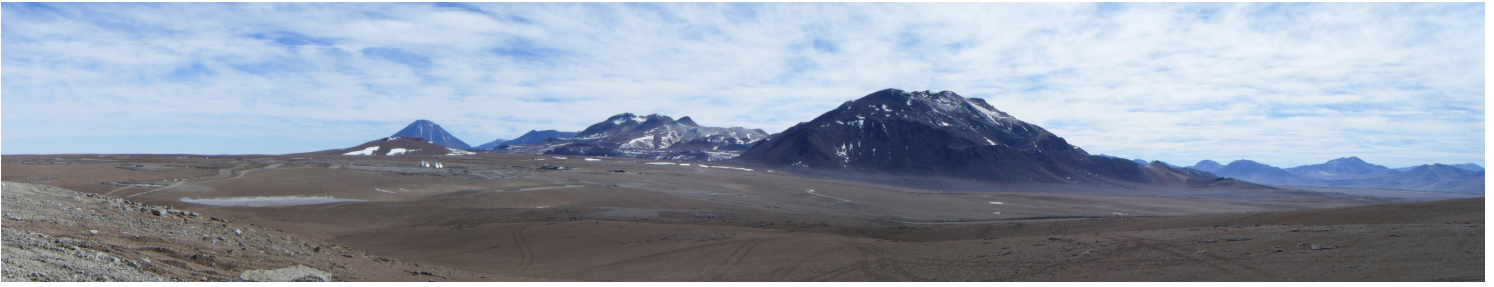

Figure 2: Panorama toward Chajnantor Volcano (center), from the access road to the upper antenna pads. About half way from the center to the left edge of the photo, toward cone-shaped Licancabur Volcano, five antennas (mid-July 2010) can be seen. The AOS support building is to the right of the antennas. Antenna pads will eventually extend over nearly the entire plateau region visible in this photo, plus several km behind the photographer. (Photo courtesy G. Schieven)

## Purpose of this Document

This document is designed to provide background information on ALMA and its capabilities during the *Early Science* stage of operations (when the telescope will become available to the general community but with limited capabilities compared to the completed array) plus basic terminology and concepts related to radio interferometry. Our goal is that, with all the basic information in one place, and a few examples of how to plan a science observation, this document can help all astronomers become familiar with ALMA's capabilities and to start planning their own ALMA observations during *Early Science*. Sections specific to *Early Science* are indicated in this document with an orange background.

## A List of Relevant Acronyms

ALMA	Atacama Large Millimeter/submillimeter Array
ACA	ALMA Compact Array
AOS	Array Operations Site (at 5000 m elevation)
ARC	ALMA Regional Center
CASA	Common Astronomy Software Applications
DSO	ALMA Division of Science Operations
ES	<i>Early Science</i>
FOV	Field of View
JAO	Joint ALMA Observatory
NAASC	North American ALMA Science Center
NAOJ	National Astronomical Observatory of Japan
NRAO	National Radio Astronomy Observatory
OSF	Operations Support Facility (at 2900 m elevation)
OT	Observing Tool
SCO	Santiago Central Office, headquarters of the JAO
TPA	Total Power Array

### Learn More

Go to

<http://www.almaobservatory.org/en/about-alma/acronyms>

for a list of the most commonly used ALMA acronyms.



Figure 3: Operations Support Facility (OSF). Inside this building are offices, receiver labs, conference rooms, and the Array control room. In front are two antennas being commissioned. Photo courtesy J. Di Francesco.

## What is ALMA?

The Atacama Large Millimeter/submillimeter Array (ALMA) will be a single research instrument composed of 66 reconfigurable high-precision antennas (see Figures 7 & 8), located on the Chajnantor plain of the Chilean Andes at an elevation of about 5000 m and at a latitude of  $-23^{\circ}$ . ALMA will consist of fifty 12 m antennas in the 12-m Array, as well as twelve 7 m antennas in the ALMA Compact Array (ACA) and four 12 m antennas forming the Total Power Array (TPA).

ALMA will be a complete imaging and spectroscopic instrument for the millimeter/submillimeter regime, providing scientists with capabilities and wavelength coverage which complement those of other research facilities of its era, such as the Expanded Very Large Array (EVLA), James Webb Space Telescope (JWST), and planned large-aperture ( $\sim 30$  m) optical telescopes. ALMA will enable transformational research into the physics of the cold Universe, regions that are optically dark but shine brightly in the millimeter portion of the electromagnetic spectrum. Providing astronomers a new window on celestial origins, ALMA will probe the first stars and galaxies and directly image the disks in which planets are formed.

ALMA, an international astronomy facility, is a partnership of Europe, North America and East Asia in cooperation with the Republic of Chile. ALMA is funded in Europe by the European Organization for Astronomical Research in the Southern Hemisphere (ESO), in North America by the U.S. National Science Foundation (NSF) in cooperation with the National Research Council of Canada (NRC) and the National Science Council of Taiwan (NSC), and in East Asia by the National Institutes of Natural Sciences (NINS) of Japan in cooperation with



Figure 4: Map of Chile, showing the location of ALMA (red star).

### Learn More

Click on

<http://www.nrao.edu/explorer/alma/>  
for the ALMA Explorer, an interactive “virtual visit” to the ALMA site and surrounding areas.

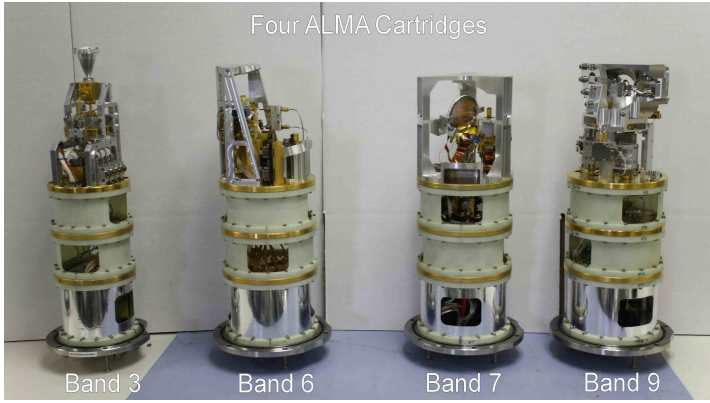

Figure 5: Four of the ALMA receiver cartridges. Eventually ALMA antennas will be equipped with at least seven receiver cartridges, covering Bands 3-10 (see Table, page 10). The Band 3 cartridges are being constructed in Canada by HIA, Band 6 in the U.S. by NRAO, Band 7 in France by IRAM, and Band 9 in the Netherlands by SRON. Bands 4, 8, and 10 are being constructed in Japan by NAOJ in collaboration with U. Tokyo.

the Academia Sinica (AS) in Taiwan. ALMA construction and operations are led on behalf of Europe by ESO, on behalf of North America by the National Radio Astronomy Observatory (NRAO), which is managed by Associated Universities, Inc. (AUI) and on behalf of East Asia by the National Astronomical Observatory of Japan (NAOJ). The Joint ALMA Observatory (JAO) provides the unified leadership and management of the construction, commissioning, and operation of ALMA.

Unlike most radio telescopes, the ALMA antennas will be at a very high altitude of 5000 m on the Llano de Chajnantor in northern Chile (see Figure 4). This is more than 750 meters higher than Mauna Kea and more than 2300 meters higher than Cerro Paranal. Decade-long monitoring studies of the sky above this site have shown it to have the dryness and stability essential for ALMA (Figure 6). The site is large and open, allowing easy re-positioning of the antennas over an area at least 16 km in extent.

ALMA Chilean operations will be the responsibility of the JAO. The telescope array itself is located at the Array Operations Site (AOS; see Figure 32). Due to the limited oxygen at 5000 m, the array will be operated from the Operations Support Facility (OSF; see Figure 3) at an elevation of 2900 m, with trips to the AOS to install, retrieve, or move equipment and antennas. OSF site facilities include offices, labs, staff residences, and a contractor camp. The OSF will handle the ongoing operations, maintenance, and repairs of ALMA antennas and receivers. The JAO has a central office in Santiago (see Figure 12).

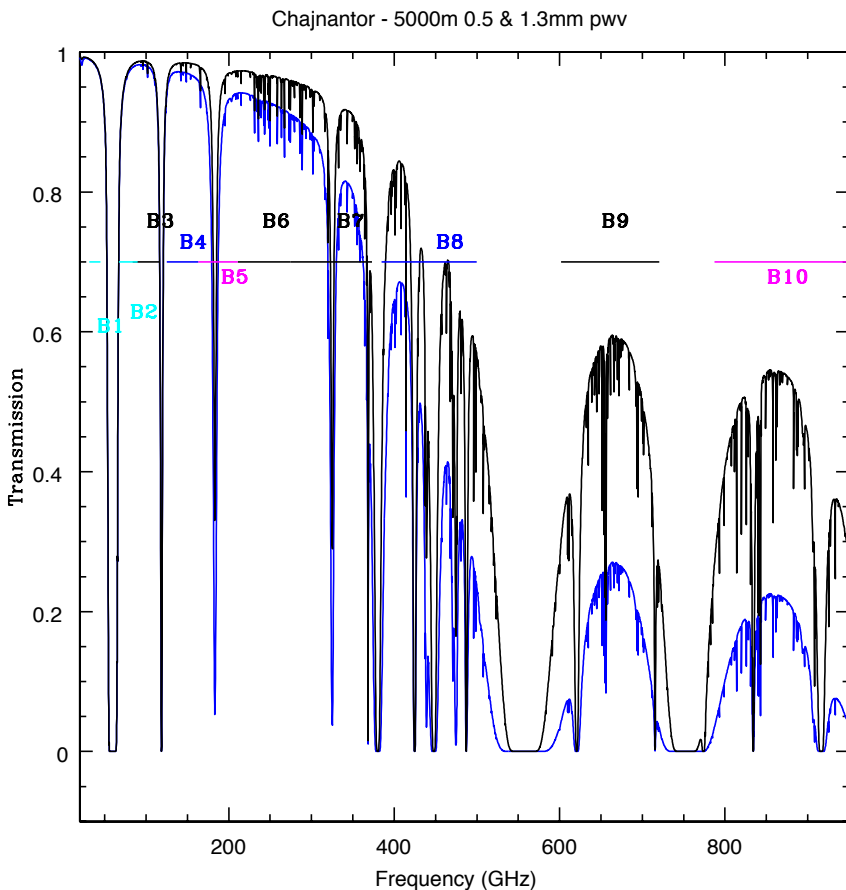

Figure 6: Curves showing the transparency of the atmosphere above the ALMA site as a function of frequency. Plotted in blue and black are the transparency values for the 50th, and 12.5th percentile weather conditions respectively averaged over the year. The horizontal lines represent the frequency coverage of the ALMA receiver bands.

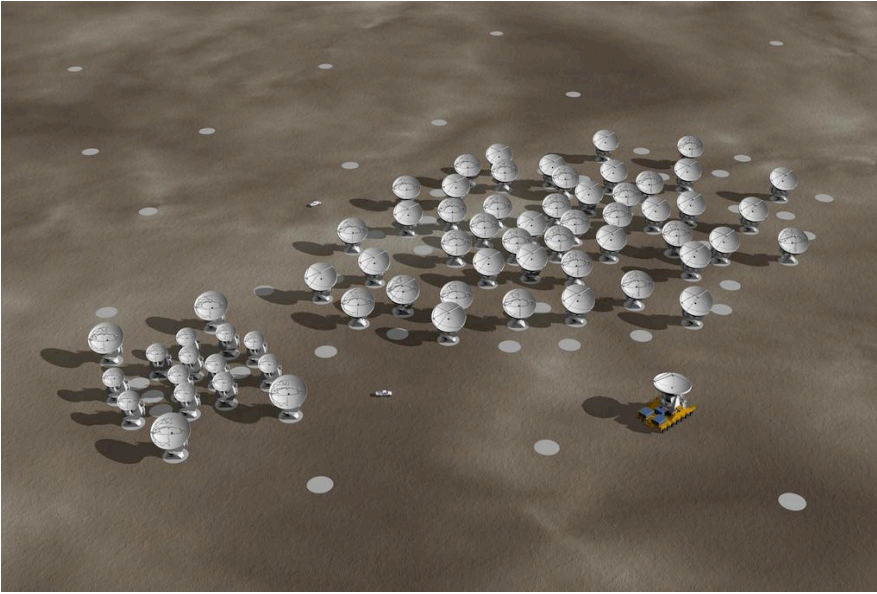
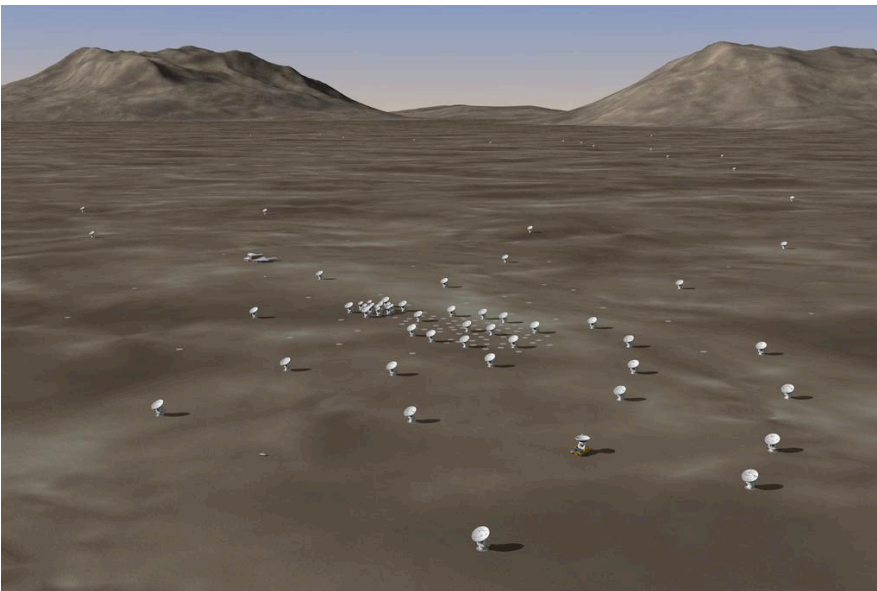

Figure 7: Artists conception of the ALMA 12-m Array compact configuration, with the ACA and TPA toward the left, and the transporter in the lower right. The ACA and TPA will not be available for Early Science. A few unoccupied pads can be seen, to which antennas of the 12-m Array can be moved by the transporter as the array is being reconfigured. At its most extended configuration, antennas in the 12-m array will be up to 16 km apart (see Figure 8).  
© ALMA (ESO/NAOJ/NRAO)

## What is Interferometry?

In contrast to direct imaging technology like a CCD camera, the image quality from an interferometer depends on more than pure sensitivity. An interferometer reconstructs an image of the sky from measurements of specific spatial scales, i.e. measurements of the Fourier transform of the sky brightness. The raw data, called "visibilities", correspond to measurements at single positions in Fourier transform space, and thus the reconstructed image quality is very sensitive to the "*uv*-coverage" — how completely the raw visibility data covers the range of real spatial frequencies on the sky. For example, if you take a very short "snapshot" observation with an interferometer, the "*uv*-coverage" will be a set of points corresponding to each independent baseline, with positions in Fourier space related to the distance between each pair of antennas. You will have sampled a very small fraction of Fourier parameter space, and the resulting image will be much poorer than implied by a sensitivity calculation (see *uv*-coverage plots in Figure 11). One increases the *uv*-coverage by changing the relative positions of the antennas as projected in the source direction, by (1) the rotation and foreshortening of baselines due to Earth rotation over time (up to 12 hours); (2) reconfiguring the telescopes to provide new baselines and observing again (see figs. 7 & 8); and/or (3) adding more antennas to the array to improve the instantaneous *uv*-coverage. With ALMA



both (1) and (2) are possible and (3) is why ALMA will ultimately have 66 antennas (50x12-m array + 12x7-m ACA + 4x12-m TPA). (For a more detailed description of these terms, see "Interferometry Concepts for ALMA" starting on page 37.

Figure 8: The 50 antennas of the ALMA 12-m array will be reconfigurable by moving antennas to pads scattered across the Chajnantor plain. Here we see an artist's conception of an extended configuration, where antennas are spaced as far apart as 16 km. The AOS is the small building left of center of the picture, and the tight clump of antennas near the center is the ACA and TPA. © ALMA (ESO/NAOJ/NRAO)

## What is *Early Science*?

In 2011 the astronomical community will have the opportunity to propose to observe with the facility with reduced (but still substantial) capability and somewhat less support than will be available during Full Operations.

### **Early Science Key Dates**

- March 31 2011: Call for Proposals for “Cycle 0” issued, Science Portal open, Helpdesk and OT available
- April 29 2011: Deadline for submission of “Notice of Intent” (not binding)
- June 1 2011: Science Archive opens for proposal submission
- June 30 2011: Proposals due 1500UT
- September 2011: Feedback from review process
- October 2011: *Early Science cycle 0* observing begins

### **During *Early Science*, ALMA’s capabilities will include:**

- At least sixteen 12-meter antennas in the ALMA array, yielding sensitivities ~10% of the full ALMA
- Maximum baselines 125 m & 400 m in two configurations, yielding angular resolutions as fine as ~0.8” or 0.25” respectively at Band 9
- Wavelength coverage in Bands 3, 6, 7 & 9 (see table page 10)
- Single field imaging, and small mosaics (of up to 50 pointings)
- Up to 14 spectral/continuum (correlator) modes (see table page 9)
- Bandwidths from 58.6 MHz to 2 GHz (see table page 9)
- Users should consult the Call for Proposals issued by the JAO and ARCs for an exact description of what capabilities will be available.

### **During Full Operations, ALMA’s capabilities will include:**

- Fifty 12-meter antennas (the *12-m Array*) for sensitive, high-resolution, high fidelity imaging
- Four additional 12-meter antennas providing total power (TPA) and twelve 7-meter antennas comprising the ACA, enhancing the fidelity of wide field imaging
- Imaging ability in all atmospheric windows from 3.5 millimeters to 300 microns (84 - 950 GHz), with coverage extending to 10 millimeters (30 GHz) possible through future receiver development
- *12-m Array* configurations with maximum baselines from 150 m to 16 km
- ACA configurations with baselines ranging from 9 m to 50 m
- Ability to image sources many arcminutes across (i.e. accurately recover diffuse structures up to arcminutes in size) at sub-arcsecond resolution
- Angular resolution as small as 5 milliarcseconds at 950 GHz
- Flexible spectrometer (correlator) modes, with as many as 32 separate spectral windows within the 8 GHz passband (per polarization)
- Velocity resolutions as fine as 8 m/s ( $\times 300/\nu$  GHz)
- Ability to “split” the array into several sub-arrays, which could observe different frequencies/targets simultaneously
- Full Stokes polarization capability



## ALMA *Early Science* Capabilities

During *Early Science*, 16 antennas will be available, each with four receiver bands (see table page 10), in two configurations, the Compact Configuration (baselines from 18 m to 125 m) and the Extended Configuration (baselines from 36 m to 400 m).

Receiver Band	Frequency (GHz)	Angular Resolution (")	Maximum Scale (")	Field of View (")	5 $\sigma$ RMS in 1 hour (mK) continuum	5 $\sigma$ RMS in 1 hour (mJy/beam) continuum	3 $\sigma$ RMS in 4 hours (K) per 1 km/s channel
<i>Properties of Compact Configuration (baselines ~18 m to ~125 m)</i>							
3	100	5.3	21	62	0.65	0.14	0.030
6	230	2.3	9	27	1.0	0.20	0.029
7	345	1.55	6	18	1.8	0.37	0.043
9	675	0.8	3	9	15	3.2	0.27
<i>Properties of Extended Configuration (baselines ~36 m to ~400 m)</i>							
3	100	1.56	10.5	62	7.6	0.14	0.35
6	230	0.68	4.5	27	11	0.20	0.34
7	345	0.45	3.0	18	20	0.37	0.50
9	675	0.23	1.5	9	175	3.2	3.1

The ALMA Correlator is an immensely powerful and flexible instrument, but during *Early Science* a limited set of modes will be supported. The following modes are available for *Early Science*.

## ALMA *Early Science* Correlator Modes

Mode	Polarization	Bandwidth per baseband (MHz)	Nchan	Spacing (MHz)	Mode	Polarization	Bandwidth per baseband (MHz)	Nchan	Spacing (MHz)
1	Single	1875	7680	0.244	7	Dual	1875	3840	0.488
2	Single	938	7680	0.122	8	Dual	938	3840	0.244
3	Single	469	7680	0.061	9	Dual	469	3840	0.122
4	Single	234	7680	0.0305	10	Dual	234	3840	0.061
5	Single	117	7680	0.0153	11	Dual	117	3840	0.0305
6	Single	58.6	7680	0.00763	12	Dual	58.6	3840	0.0153
71	Single	2000 <sup>#</sup>	256	7.8125	69	Dual	2000 <sup>#</sup>	128	15.625

Note that the velocity resolution will be 2 x spacing due to a default Hanning filter applied to the data. Up to 4 basebands will be available. Mixed band modes will not be possible during *Early Science*.

<sup>#</sup>Note: Because of an anti-aliasing filter, the useful (effective) bandwidth of this mode is 1.875GHz.

## ALMA Full Array Specifications

	Specification
<i>Number of Antennas</i>	<i>At least 50×12 m, plus 12×7 m &amp; 4×12 m total power antennas</i>
<i>Maximum Baseline Lengths</i>	<i>0.15 - 16 km</i>
<i>Angular Resolution (")</i>	<i>0.2" × (300/√ GHz) × (1 km / max. baseline)</i>
<i>12m Primary beam<sup>+</sup> (")</i>	<i>20.6" × (300/√ GHz)<sup>+</sup></i>
<i>Number of Baselines</i>	<i>Up to 2016 (ALMA correlator can handle up to 64 antennas)</i>
<i>Effective Bandwidth</i>	<i>16 GHz (2 polarizations × 4 basebands × 2 GHz/baseband)</i>
<i>Velocity Resolution</i>	<i>As narrow as 0.008 × (√/300GHz) km/s</i>
<i>Polarimetry</i>	<i>Full Stokes parameters</i>

<sup>+</sup> Note that the Primer uses the usual definition of primary beam diameter  $\sim 1.2\lambda/D$ , whereas the Observing Tool (OT) uses  $\lambda/D$  to define the primary beam size, where  $\lambda$  is the observed wavelength and  $D$  is the diameter of the antenna.

For an integration time of 60 seconds and a spectral resolution of 1 km/s, the brightness temperature sensitivity  $\Delta T$ , with a 50 antenna array and "compact" vs. most "extended" array configuration, will be (from the ALMA Sensitivity Calculator (see page 41) adopting the default weather conditions<sup>†</sup>):

Band	Frequency (GHz)	Wave-length (mm)	Primary Beam (FOV; ")	Ap-prox. Largest Scale (")	Continuum Sensitivity (mJy/beam)	Compact		Most Extended	
						Angular Resolution (")	$\Delta T_{\text{line}}$ (K)	Angular Resolution (")	$\Delta T_{\text{line}}$ (K)
1 <sup>†</sup>	31.3-45	6.7-9.5	145-135	93	‡	13-9	‡	0.14-0.1	‡
2 <sup>†</sup>	67-90	3.3-4.5	91-68	53	‡	6-4.5	‡	0.07-0.05	‡
3	84-116	2.6-3.6	72-52	37	0.05	4.9-3.6	0.07	0.05-0.038	482
4	125-163	1.8-2.4	49-37	32	0.06	3.3-2.5	0.071	0.035-0.027	495
5	163-211	1.4-1.8	37-29	23	*	*	*	*	*
6	211-275	1.1-1.4	29-22	18	0.10	2.0-1.5	0.104	0.021-0.016	709
7	275-373	0.8-1.1	22-16	12	0.20	1.5-1.1	0.29	0.016-0.012	1128
8	385-500	0.6-0.8	16-12	9	0.40	1.07-0.82	0.234	0.011-0.009	1569
9	602-720	0.4-0.5	10-8.5	6	0.64	0.68-0.57	0.641	0.007-0.006	4305
10	787-950	0.3-0.4	7.7-6.4	5	1.2	0.52-0.43	0.940	0.006-0.005	—

<sup>†</sup>To be developed in the future.

\* Available on a limited number of antennas

<sup>†</sup>Note: These sensitivities were calculated using the expected receiver temperatures at the time of writing, and may not represent the values that are currently available. For the most up-to-date values, use the ALMA Sensitivity Calculator.

## ALMA Regional Centers (ARCs)

Each of the three ALMA regional partners (Executives) maintain an ALMA Regional Center (ARC) within its respective region. The ARCs provide the gateway to ALMA for astronomers, whether for information, assistance through the Helpdesk, for submitting proposals and scheduling blocks through the OT, or acquiring data through the archive.

The North American ALMA Science Center (NAASC) based at NRAO headquarters in Charlottesville, VA, USA, with the assistance of the National Research Council of Canada's Herzberg Institute of Astrophysics (NRC-HIA), is responsible for supporting the science use of ALMA by the North American and Taiwan astronomical communities, and for research and development activities in support of future upgrades to ALMA.

European researchers are supported by the EU-ARC, based at the ESO headquarters in Garching, Germany, along with regional nodes based in several ESO member countries.

### Learn More

The three ARCs can be reached through their web sites:

NAASC <http://science.nrao.edu/facilities/alma/>

EU-ARC <http://www.eso.org/sci/facilities/alma/arc/>

EA-ARC <http://alma.mtk.nao.ac.jp/e/forresearchers/arc>

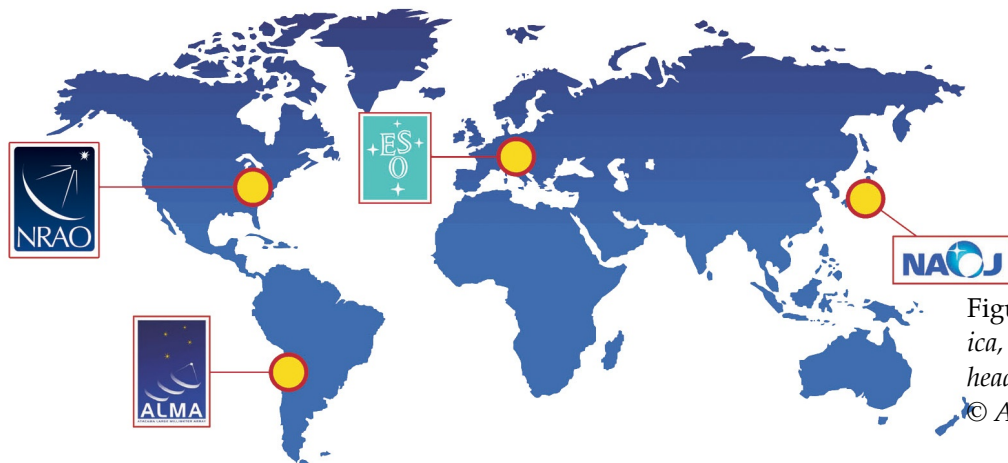

The East Asian ARC (EA-ARC) is based at the NAOJ headquarters in Tokyo, in collaboration with Academia Sinica Institute of Astronomy and Astrophysics (ASIAA), and supports the astronomy communities of Japan and Taiwan.

Figure 9: ARCs are located in North America, Europe, and East Asia. The ALMA headquarters are located in Santiago, Chile © ALMA (ESO/NAOJ)/NRAO).

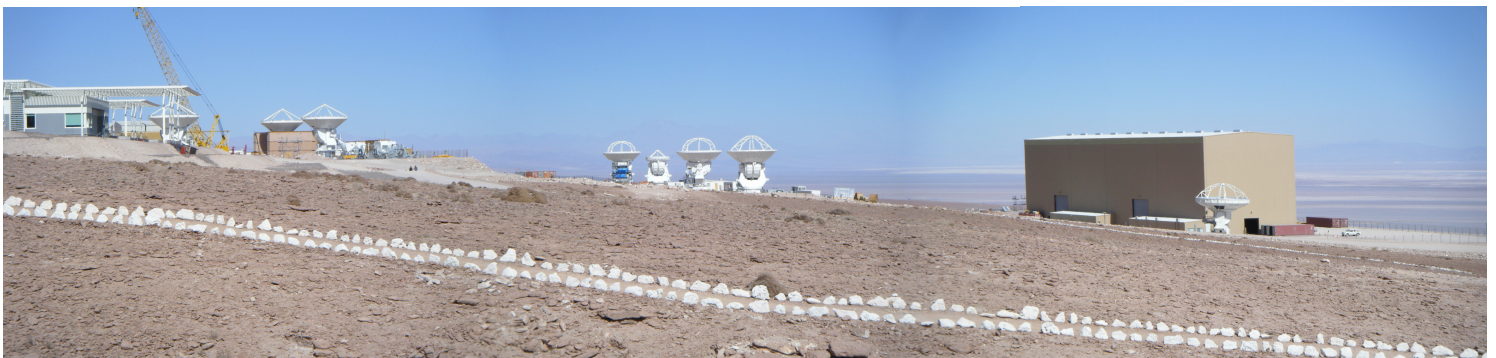

Figure 10: Antenna assembly area at the OSF. At right is the Vertex (NA) assembly building with one antenna awaiting final testing before handover to the antenna integration and verification team, at center are four of the Mitsubishi (EA) antennas in various stages of assembly (note the smaller 7m ACA antenna), and at left are three nearly fully-assembled Alcatel (EU) antennas plus several more in sections. (Photo courtesy G. Schieven)

# Science with ALMA

## ALMA During *Early Science*

At the start of *Early Science*, ALMA will already be a powerful millimeter/submillimeter interferometer, and a broad range of science topics can be addressed with the array in this period. A number of *Early Science* example projects suitable for the first Call for *Early Science* Proposals has been compiled by the world-wide ALMA science staff and can be found on pages 15 to 28.

Observations during *Early Science* will be performed in service observing mode by ALMA Operations personnel on a “best efforts” basis. A high priority will be placed on completing projects, but completion cannot be guaranteed during *Early Science*.

For *Early Science* as for Full Operations, the following will apply. All science and calibration raw data will be captured and archived. The JAO will monitor the data quality while the data are being acquired. When the project is completed, reliable images, calibrated and quality assured according to a detailed calibration plan, will be generated. The astronomer will then be provided with these images, plus the raw data and all scripts and tables (calibration and flagging) used to generate the images, plus the observing logs and quality assessment reports, via the archive at the appropriate ARC.

## Level One Science Aims for Full Operations

While ALMA will revolutionize many areas of astronomy, the ALMA Project has three Level One Science Aims for Full Operations that drive its technical requirements:

- I. The ability to detect spectral line emission from CO or C<sup>+</sup> in a normal galaxy like the Milky Way at a redshift of  $z = 3$ , in less than 24 hours of observation.
- II. The ability to image gas kinematics in a solar-mass protostellar/protoplanetary disk at a distance of 150 pc (roughly, the distance of the star-forming clouds in Ophiuchus or Corona Australis), enabling one to study the physical, chemical, and magnetic field structure of the disk and detect the tidal gaps created by planets undergoing formation.
- III. The ability to provide precise images at an angular resolution of 0.1". Here the term "precise image" means an accurate representation of the sky brightness at all points where the brightness is greater than 0.1% of the peak image brightness. This requirement applies to all sources visible to ALMA that transit at an elevation greater than 20 degrees.

## ALMA's Breadth of Science

When completed (i.e. during Full Operations), ALMA will also be able to:

- Image the redshifted dust continuum emission from evolving galaxies at epochs of formation as early as  $z = 10$ . The inverse K-correction on the Rayleigh-Jeans side of the spectral energy distribution of a dusty galaxy compensates for dimming at high redshift, making ALMA the ideal instrument for investigating the origins of galaxies in the early universe, with confusion minimized by the high spatial resolution.
- Use the emission from CO to measure the redshift of star-forming galaxies throughout the universe. The frequency spacing between successive transitions of CO shrinks with redshift as  $1/(1 + z)$ , and the large instantaneous total bandwidth of ALMA will make possible blind surveys in order to establish the star-forming history of the universe, without the uncertainties inherent in optical and UV studies caused by dust extinction.

- Probe the cold dust and molecular gas of nearby galaxies, allowing detailed studies of the interstellar medium in different galactic environments, the effect of the physical conditions on the local star formation history, and galactic structure. The resolution of ALMA will reveal the kinematics of obscured active galactic nuclei and quasars on spatial scales of 10-100 pc and will be able to test unification models of Seyfert galaxies.

- Reveal the details of how stars form from the gravitational collapse of dense cores in molecular clouds. The spatial resolution of ALMA will enable the accretion of cloud material onto an accretion disk to be imaged and will trace the formation and evolution of disks and jets in young protostellar systems. For older protostars and (pre-)main sequence stars, ALMA will show how (proto)planets sweep gaps in protoplanetary and debris disks.

- Uncover the chemical composition of the molecular gas surrounding young stars. For example, establishing the role of the freeze-out of gas-phase species onto grains and the re-release of these species back into the gas phase in the warm inner regions of circumstellar disks. ALMA will have the large total bandwidth, high spectral resolution, and sensitivity needed to detect the myriad lines associated with the heavy, pre-biotic molecules that may have been present in the young Solar System.

- Image the formation of molecules and dust grains in the circumstellar shells and envelopes of evolved stars, novae, and supernovae. ALMA will resolve the crucial isotopic and chemical gradients within these circumstellar shells, which reflect the chronology of the invisible stellar nuclear processing and early seeding of the ISM.

- Refine dynamical and chemical models of the atmospheres of planets in our own Solar System and provide unobscured images of cometary nuclei and hundreds of other Solar System objects.

## Before You Propose for *Early Science*

In order to be able to submit proposals using the OT, or request help from the Helpdesk, you will need to be registered through the ALMA Science Portal.

When putting together a proposal for *Early Science* using the OT, one should have at hand:

- A Science Case
- Source coordinates
- Observing frequency, bandwidth, velocity resolution
- Required spatial resolution and largest angular scale. The ACA and TPA will not be available for *Early Science*, so sources which have complex structure, or are significantly extended may be better candidates for Full Operations. If your source is small, however, *Early Science* may be well suited to your needs.
- Sensitivity and dynamic range needed. The dynamic range in an image improves with the length of the observation and the number of baselines (which goes nearly with the square of the number of antennas). Fields where there is a bright source but where the faint emission is of interest may be better observed during Full Operations.

### Learn More

Resources for Scientists (including the Science Portal and ALMA Science Archive) can be found at

<http://almascience.org/>

### Learn More

About the ALMA Sensitivity Calculator at

<http://almascience.eso.org/call-for-proposals/sensitivity-calculator>

During *Early Science* with 16 antennas, ALMA will have comparatively poor "snapshot" (< 1h observation) *uv*-coverage compared to the full ALMA array, with only 120 independent base-

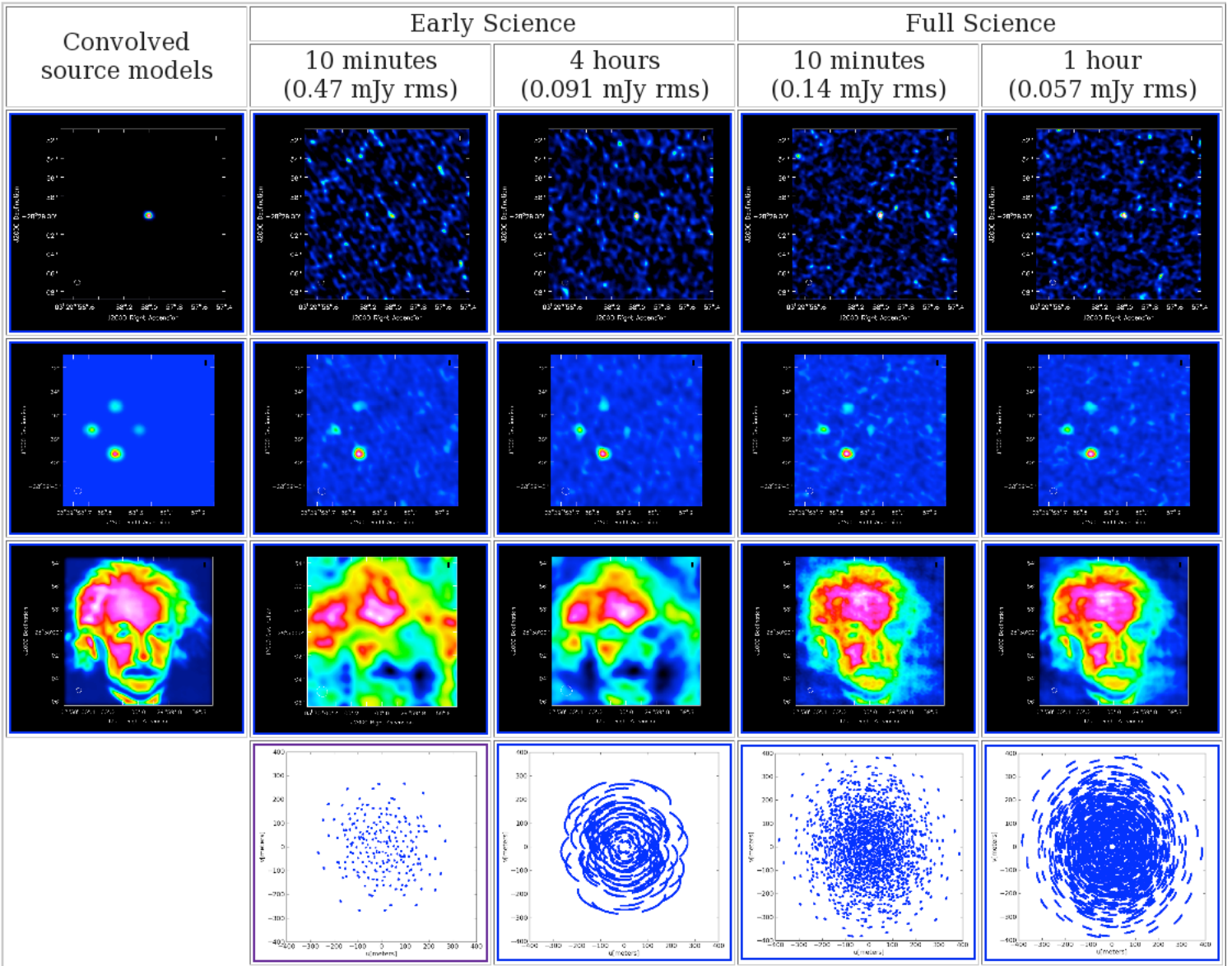

Figure 11: Examples of use of the CASA Simdata simulator at 345GHz (ALMA Band-7). The images are about 16" on a side, approximately the size of the primary beam, and the resolution is about 0.6", using a configuration with maximum baseline 250 m. All images were restored using the CLEAN algorithm. Top row: a point source, with the input model scaled to yield  $5\sigma$  in each image. Left to right: the model convolved with a Gaussian representation of the Full Science beam, the Early Science image in 10 minutes, the Early Science image in 4hr, the Full Science image in 10 minutes, the Full Science image in 1hr. Second row: four point sources with the faintest source being  $5\sigma$  in all the images, and other sources being 10, 20 and  $40\sigma$ . Image details are the same as for the top row. It is notable that with the relatively sparse  $uv$ -coverage of the Early Science array in 10-min, it is not as easy to detect a  $5\sigma$  source as one might expect. Third row: an "extended" source, i.e. the face of Albert Einstein, demonstrating the ability of the different observations to image complex structures. Image details are the same as for the top row. Bottom row: plots of the  $uv$ -coverage for each of the above simulated images. The Full Science configuration used was a moderately compact configuration of the 12-m Array (i.e. did not include the ACA or TPA). "Early Science" configurations had not been released at the time of this simulation.

lines (though this is better than most existing millimeter arrays). Thus, if your science aim involves imaging something more complex than a point source, the  $uv$ -coverage is as important to consider as sensitivity. For such cases, it is very important to provide information in your technical justification about the required  $uv$ -coverage needed to achieve your imaging requirements. Note that during Full Science with 50 antennas in the 12-m array and thus 1,225 baselines, the "snapshot" coverage will be sufficiently good

that these issues will be less critical except for very complex fields and/or very high dynamic range requirements.

If you have a reasonable model for your source structure and brightness, an ALMA simulator (e.g. *Simdata* in CASA) can be used to test and demonstrate the *uv*-coverage needed to achieve your imaging requirements (see for example Figure 11).

Alternatively, comparison with existing similar interferometric data, accounting for differences in the number of baselines and sensitivity can be used. For the ALMA *Early Science* examples in the following section we reference where possible existing interferometer results to approximately describe the necessary *uv*-coverage. Note that one will not be able to request specific observing times or tracks, though efforts will be made to obtain the necessary *uv*-coverage to achieve the stated science aims. As an example of what *Simdata* can do, and an illustration of how data taken during *Early Science* will compare to those taken using the Full Science array, we show some examples in Figure 11. Note that the Full Science array, with 50 antennas compared to 16 in *Early Science*, is not only more sensitive, but will also produce much higher quality images. The Full Science array will sample the aperture nearly ten times better than the *Early Science* array, accurately measuring structure over a wide range of spatial frequencies.

**Learn More**

about simulating ALMA data with *Simdata*, at  
<https://almascience.nrao.edu/document-and-tools>  
or the web-based Observation Support Tool at  
<http://almaost.jb.man.ac.uk/>

## Examples of *Early Science* Observing With ALMA

In the following sections we provide a few examples of observations that could be done with ALMA during *Early Science*, and include screenshots of the OT illustrating aspects of the observing set-up.

**Note that these examples use the sensitivities and capabilities of ALMA for *Early Science* as they were known at the time of the Cycle 0 Call for Proposals. Any astronomer proposing observations with ALMA for *Early Science* should carefully check the published capabilities and sensitivities at the time of the Call.** Note also that the following time estimates do not include “overheads”.

For each example below, we start with a brief *science aim* and discuss the required *receiver band* at which the observations should be undertaken. Next, we determine the *angular resolution* and required maximum baselines needed. Where multiple frequencies are requested, the angular resolution obtained will vary with frequency. The necessary *spectral resolution* is discussed to provide the appropriate *correlator settings* (see table page 9). As well, the *continuum* or *channel sensitivity* is quantified so the on-source *observing time* can be calculated. Users who are unfamiliar with these terms, or who would like a “refresher” on radio interferometry terms and concepts, should first read “Interferometry Concepts for ALMA” starting on page 37.



Figure 12: Santiago Central Office (SCO) of the JAO. © ALMA (ESO/NAOJ/NRAO).

# A Survey of Molecular Gas and Dust in Submillimeter Galaxies

**Science Aim:** *To measure the positions and redshifts of SMGs*

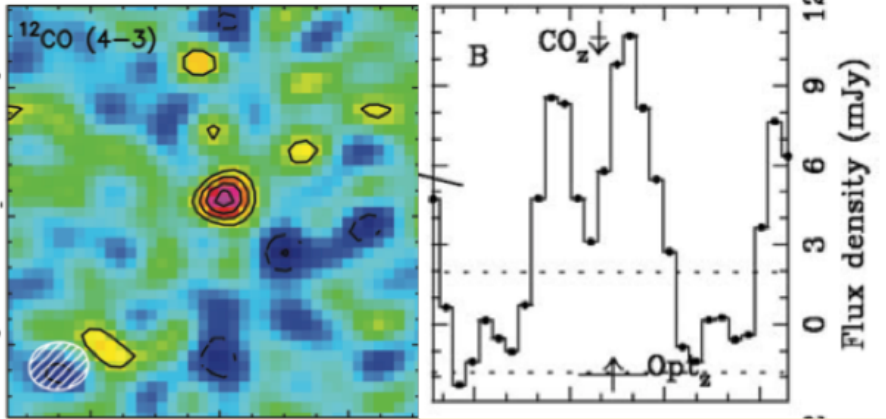

Figure 13: **Left:** Integrated intensity of CO in SMG J1000+0234 at  $z=4.5$  detected by PdBI (Schinnerer et al. 2008, *ApJ*, 689, L5). **Right:** CO (3-2) spectrum (50 km/s channels) obtained at OVRO for SMM J16359+6612 (Sheth et al. 2004, *ApJ*, 614, L5). During Early Science, ALMA may be used to follow up single-dish-detected SMGs to identify counterparts, obtain redshifts, and measure their molecular gas and dust mass.

A large fraction of the star formation activity at the epoch of galaxy evolution ( $1 < z < 3$ ) is traced by submillimeter galaxies (SMGs). SMGs are typically detected with single-dish telescopes with coarse resolution; identification of a counterpart has required deep radio (centimeter) observations followed by deep optical or near-infrared spectroscopy. With ALMA, we can precisely locate SMGs and obtain a redshift using sequential observations to cover an entire ALMA band in order to detect one or more highly redshifted CO lines. Given the limited  $uv$ -coverage of ALMA at *Early Science*, spatially resolved observations are better suited to Full Science. In this example we layout a strategy to pinpoint 50 sources with continuum data and a pilot program to obtain redshifts for 5 SMGs.

**Receiver Band:** Band 3 (spectral line, 85-115 GHz) and Band 7 (Continuum, 345 GHz)

**Angular Resolution:** 1.5" (spectral line, Band 3) and 0.5" (continuum, Band 7). These values assume a maximum baseline length of 400 m. A good rule of thumb is that 1" corresponds to  $\sim 8$  kpc for  $z > 1$ , so spatially resolved observations could be made during *Early Science* (in Band 7 in the 400 m configuration), though the short observations proposed here won't provide sufficient  $uv$ -coverage for spatially resolving a galaxy with high fidelity imaging.

**Spectral Resolution:** For Band 7 continuum measurements, we use correlator mode 69 which provides a full 15 GHz of effective bandwidth ( $2 \times 3.75$  GHz  $\times$  2 polarizations). For Band 3 CO measurements, we use correlator mode 7 which provides  $1.875$  GHz  $\times$  2 basebands = 3.75 GHz of spectral bandwidth in each sideband with 488 kHz channels (976 kHz resolution). The very high spectral resolution of this mode is not necessary for this science aim, so our estimate of the time required assumes averaging to 100 km/s channels.

**Continuum (Band 7) Sensitivity:** We plan to survey all COSMOS-AzTEC sources with  $S_{1.1\text{mm}} > 3.5$  mJy. Given the exceptional atmospheric conditions at ALMA, we choose to pinpoint these sources at a higher frequency (345 GHz or 0.8 mm) where they are significantly brighter ( $S \propto \nu^\beta$ , typically  $\beta \sim 2$ ). Therefore, these sources should have  $S_{0.8\text{mm}} > 5$  mJy. It is possible that these sources may be extended or may resolve into more than one source, so we aim to get a  $S/N \sim 10$ , adequate to identify the counterparts and obtain excellent relative astrometric accuracy, which is usually estimated as  $\sim \theta/(S/N)$ .

**Band 7 Observing Time:** For Band 7, the ALMA sensitivity calculator, assuming sixteen 12 m antennas and an effective 7.5 GHz continuum bandwidth per polarization, predicts 1.4 minutes integration per source to reach a  $1 \sigma = 0.5$  mJy. The total integration time for 50 galaxies would thus be  $\sim 1.2$  hrs.



**Spectral (Band 3) Sensitivity:** Bright SMGs ( $S_{0.8\text{mm}} > 5$  mJy) typically have an integrated CO flux of 1-4 Jy km/s for a range of CO transitions (see review by Solomon & Vanden Bout, 2005, ARAA, 43, 677). Assuming a CO flux of 2 Jy km/s distributed evenly over a line width of 400 km/s, we aim to detect a signal of 5 mJy. To get a S/N of 5 we need to reach 1 mJy rms sensitivity. Since *Early Science* correlator mode 7 provides a native velocity resolution of 976 kHz ( $\sim 3.0$  km/s), smoothing to a channel width of 100 km/s translates to a sensitivity goal of  $(100/3.0)^{1/2} \times 1$  mJy  $\approx 5.8$  mJy per (unbinned) channel.

**Band 3 Observing Time:** Covering most of the entire Band 3 frequency range requires setting the LO to  $\sim 5$  frequencies, namely 91.75, 95.5, 99.25, 103.0 and 106.75 GHz. (Note that this method will cover the Band 3 frequency range from 84 to 114.5 GHz, and each LO setting will cover 3.75 GHz in a sideband per setting. Note also that the spectral range from 95-103.25 GHz will be sampled twice, once in the USB and once in LSB of different LO settings). The ALMA sensitivity calculator, assuming sixteen 12 m antennas and a desired sensitivity of 5.8 mJy per 976 kHz resolution element, predicts integration times of  $\sim 12$  minutes for each LO setting. Thus each galaxy requires  $\sim 1$  hour of total integration time. For 5 galaxies, this translates to  $\sim 5$  hrs. Thus overall, this program would require  $\sim 6$  hrs of integration time (not including overheads).

**In The Future:** 50 antennas will significantly decrease the time for blind redshift searches as described above to  $\sim 1$  minute per LO setting and provide the instantaneous  $uv$ -coverage needed to map the galaxies. To do large surveys of galaxies, however, known redshifts will significantly improve the efficiency of observations. Also note that at very highest redshifts ( $z > 6$ ), Band 3 will be observing CO lines higher than J=7-6, which may not be as bright as the lower-J CO lines.

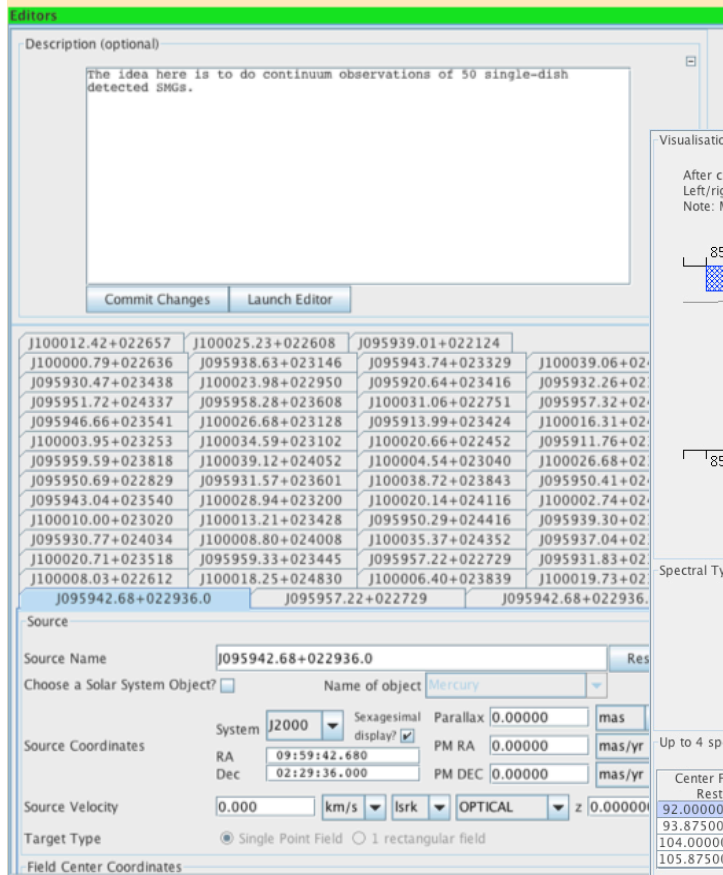

Figure 14: A screenshot of the OT target list for the continuum observations. A list of sources may be uploaded into the OT as a simple ascii file.

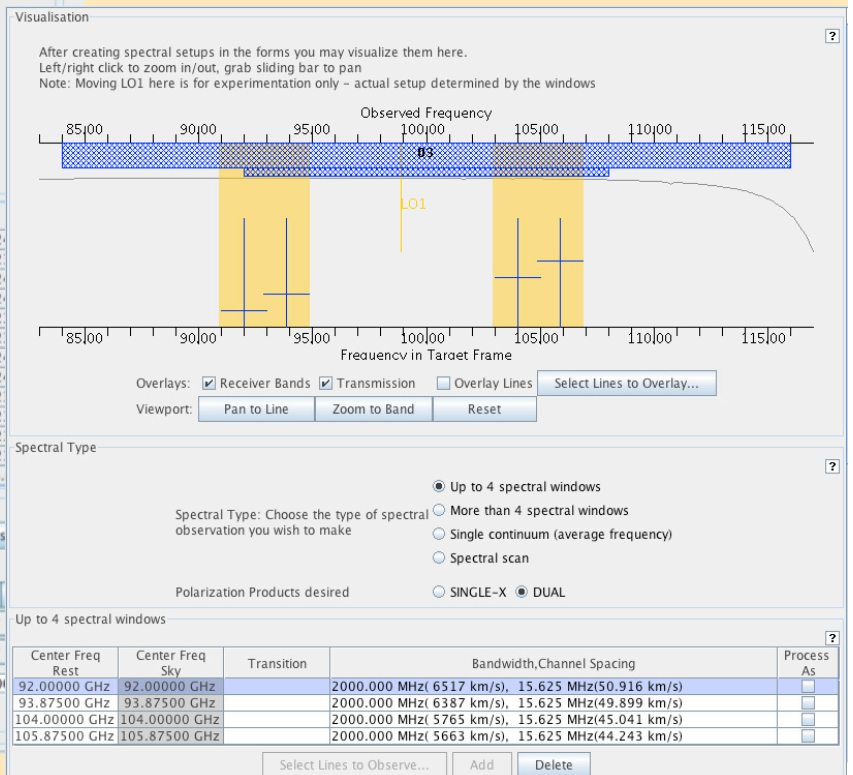

Figure 15: A screenshot of one set of LO settings for Band 3 observations to get a CO redshift for one of these SMGs.

## Mapping a Lensed High Redshift, Gas-Rich Galaxy

**Science Aim:** *To resolve the continuum and molecular gas in a distant lensed starburst galaxy*

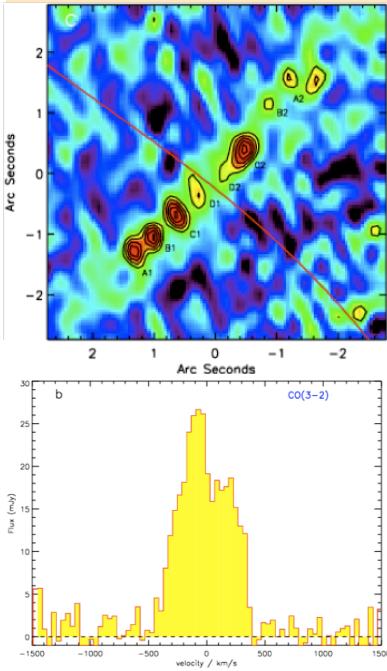

Figure 16: (above) SMA (very extended configuration) 870  $\mu\text{m}$  image of the Cosmic Eyelash. The red line marks the division between the two images of the background source. (below) Spectrum of CO(3-2) taken with the Plateau de Bure interferometer. Both figures are from Swinbank et al. (2010, *Nature*, 464, 733).

At high redshift there is a population of gas-rich starburst galaxies that are relatively bright in the submillimeter, but extremely faint in the optical due to dust obscuration. The small number that has been observed with mm/submm interferometers are unresolved, but increasing numbers are now being discovered that are gravitationally lensed and therefore brighter and larger than would otherwise be the case. A pre-eminent example of this is the so-called "Cosmic Eyelash". This consists of two images of a starburst galaxy that have a combined extent of 5". Each image has been resolved into at least four components (Fig. 16a) and large amounts of molecular gas have been detected (Fig. 16b). Although resolved, the source is small and dominated by relatively compact structures and therefore well-suited to ALMA *Early Science* observations in the high resolution (400 m max. baseline) configuration. As an example project, we will attempt to map both the continuum and the molecular gas at high frequencies where the ALMA *Early Science* array may be able to resolve the source structure.

**Receiver band:** Band 7 (spectral line and continuum, 312 GHz) and Band 9 (Continuum, 680 GHz).

**Angular Resolution:** 0.5" (spectral line [CO(9-8)] and continuum, Band 7) and 0.25" (continuum, Band 9), assuming a maximum baseline length of 400 m. Band 9 is required to spatially resolve the components revealed by the SMA.

**Spectral Resolution:** For Band 7, we use correlator mode 69 to provide 14 km/s channels (i.e., 27 km/s resolution) and a total bandwidth of 1.875 GHz ( $\sim 1800$  km/s) in one baseband. The remaining 5.6 GHz (3 basebands) can be used for mapping continuum. For Band 9, we will use a similar correlator setup covering the same bandwidth ( $4 \times 1.875$  GHz  $\times$  2 pol's).

**Spectral (Band 7) Sensitivity:** The peak flux of the CO line is  $\sim 10$  mJy. To detect the line at a sufficient S/N across the entire width of the line, we aim to achieve a S/N  $\sim 20$  at the peak in a 100 km/s channel. This requires a  $1 \sigma$  noise level of 0.5 mJy/beam. We use correlator mode 69 and average the channels to achieve the 100 km/s channel width. The ALMA sensitivity calculator with sixteen 12-m antennas predicts 1.5 hours of integration to reach  $1 \sigma = 0.5$  mJy/beam. This amount of time will also produce a sensitivity of 69  $\mu\text{Jy}/\text{beam}$  in a map of the remaining 6 GHz of line-free continuum providing a S/N  $> 15$  for the continuum signal  $\sim 1$  mJy.

**Continuum (Band 9) Sensitivity:** To measure accurate positions for lens modeling we require a S/N of at least 10 on each component. Since the source is four to five times brighter in this band, we need a  $1 \sigma$  noise level of about 0.25 mJy/beam. For 7.5 GHz per polarization, this requires 7.9 hours of integration time. Thus overall, this program would require  $\sim 9.6$  hrs of integration time (not including overheads).

**In The Future:** 50 antennas will most obviously reduce the integration times dramatically and still retain the  $uv$ -coverage required for accurate mapping. Herschel is finding large numbers of lensed systems like the Cosmic Eyelash and mapping both their molecular gas reservoirs and dust continua at high resolution with ALMA will be extremely efficient.

## Molecular Absorption Lines at $z=0.9$

**Science Aim:** *To study high-redshift absorption lines toward a bright background quasar*

Observing gas in absorption against a bright background continuum source can provide detailed information on the molecular interstellar medium of the foreground galaxy. Observations of absorption lines are very powerful because the detectability of the intervening gas depends only on the brightness of the background source. Many molecular species have already been detected in the few known intermediate-redshift absorbers, but ALMA's sensitivity and bandwidth will allow an unbiased survey for absorption lines in selected distant galaxies.

Here we prepare a spectral survey in Band 3 of PKS1830-211, where a spiral galaxy at  $z\sim 0.9$  is detected in front of the bright background quasar at  $z\sim 2.5$ . The background source is sufficiently bright ( $\sim 2$  Jy in Band 3) that short observations with the *Early Science* array will result in very good optical depth limits of about 1%. By covering a wide range of frequencies with several spectral settings, we expect to detect many molecular lines, enabling detailed comparison with the interstellar chemistry of the Milky Way interstellar medium.

**Receiver band: Band 3.** The molecules HCN, HNC, HCO<sup>+</sup>, HOC<sup>+</sup>, CS, HC<sub>3</sub>N have transitions redshifted into this band.

**Angular resolution:** In principle, angular resolution is not important for this experiment because we are looking for absorption lines against a bright background point source. However, the extended *Early Science* configuration is preferred so that the two lensed components of the quasar can be separated.

**Spectral resolution:** We plan to use correlator mode 8 which gives 3840 channels over 938 MHz in each of the four basebands. In Band 3, this setting results in a channel width of  $\sim 0.75$  km/s or a velocity resolution of  $\sim 1.5$  km/s, which is sufficient to resolve all known redshifted molecular absorption lines.

**Line sensitivity:** In order to reach 1% optical depth limits at  $5\sigma$  significance, an rms noise level of 4 mJy per channel is required in Band 3. Additional spectral smoothing can be applied to search for broader, weaker absorption features.

**Continuum sensitivity:** N/A: The background source is very bright ( $\sim 2$  Jy) and well-studied, so additional continuum observations are not required.

**Band 3 observing time:** We plan to observe with eight different frequency settings in Band 3, which will give a total coverage of 938 MHz x four basebands x eight settings = 30 GHz. This nearly covers the whole frequency range of Band 3. To reach our target line sensitivity, a total integration time of 51 minutes per setting is required, or 6.8 hours in total (not including overheads).

**In the future:** During Full Science, the same sensitivity could be achieved in only one tenth of the time. Furthermore, with longer baselines it will be possible to resolve the structure of the background source and detect absorption against the different lensed components.

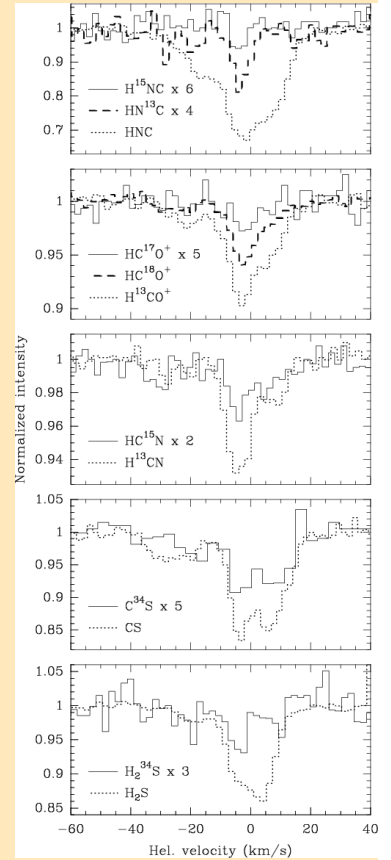

Figure 17: *Examples of molecular species and isotopomers detected against PKS1830-211 with IRAM (from Muller et. al, 2006, A&A 458, 417). During Early Science, ALMA will achieve higher signal-to-noise and higher spectral resolution on this target than the IRAM observation. Furthermore, ALMA will allow an efficient survey of the entire spectral range of Band 3, and may detect many more molecular species.*

## Observing a GRB Afterglow (A Target of Opportunity)

**Science Aim:** *Detect & monitor the mm/sub-mm afterglow of a GRB from its burst to one month later*

Long-duration gamma-ray bursts (GRBs) are the most energetic phenomena in the universe. The broad-band afterglow emission accompanying GRBs can be described quite robustly as non-thermal emission from electrons accelerated in relativistic shocks that occur as the GRB-generated outflow is decelerated by the ambient medium. At mm and sub-mm wavelengths, we can observe the synchrotron emission directly, where it is free from interstellar scintillation. Continuum monitoring at mm and sub-mm wavelengths provides information on GRB physics, not only for normal GRBs but also dark GRBs, and it sets constraints on theoretical models of GRB phenomena as well.

Only a few GRB afterglows have been detected at mm and sub-mm wavelengths, because instruments at these wavelengths have had limited sensitivity. GRB 030329, the second nearest ( $z=0.1685$ ) GRB to date, was intensively monitored at mm and sub-mm wavelengths. The GRB 030329 afterglow light curve at 100, 250, and 345 GHz showed a “plateau” for about one week after the burst, followed by a steep decline (see Figure 18; Sheth et al. 2003, ApJ, 595, L33; Kuno et al. 2004, PASJ, 56, L1; Kohno et al. 2005, PASJ, 57, 147; Smith et al. 2005, A&A, 439, 981). These data support a model with a two-component, jet-like outflow (Berger et al. 2003, Nature, 426, 145).

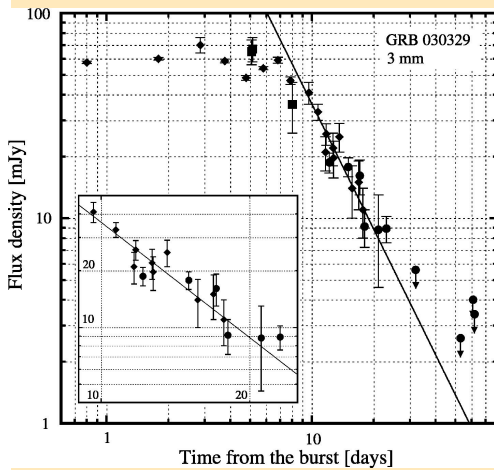

Figure 18: Millimeter-wave (3 mm=100 GHz) light curve of the afterglow GRB 030329 taken with the Nobeyama Millimeter Array (circle, Kohno et al. 2005), OVRO/BIMA (diamond, Sheth et al. 2003) and the Nobeyama 45-m telescope (square, Kuno et al. 2004). A steep decline of the afterglow ( $S \propto t^{-2.03+0.21}$  indicated by a solid line), is evident. Insertion is a close-up view of the light curve for  $\Delta t=9$  to 30 days. (this figure is taken from Kohno et al. 2005)

**Receivers:** Bands 3, 6, 7: (100 GHz, 230 GHz, and 345 GHz)

**Angular Resolution:** The sources will be unresolved, since they are about the size of a star. Hence any array configuration can be used.

**Spectral Resolution:** N/A. Each measurement will use the largest bandwidth possible in dual polarization.

**Sensitivity and Observing Time:** We design the observations to target a GRB that has a light curve like that of GRB 030329, and a redshift of  $z \sim 1$ .

Our observations will be designed to detect the continuum emission from the GRB with a signal-to-noise of at least  $\sim 5$  in each of the observing bands. For proper sampling, we must observe the target every two or three days for the first two weeks, followed by two additional epochs over the final two weeks. For the first two weeks we will make observations with all three frequency bands in order to measure the spectral energy distribution (spectral index) on each of the days. The final two epochs will observe with a single frequency band each day.

From day 0 to about day 14 after the burst, we require 1-sigma sensitivities of 0.15 mJy/beam, 0.13 mJy/beam, and 0.1 mJy/beam for Bands 3, 6, and 7, requiring 2.0, 6, and 33 minutes of on-source integration time, respectively. On about day 17, we require a Band 6 observations with 1-sigma sensitivity of 0.06 mJy/beam, amounting to 28 minutes of on-source integration. On about day 28 (four weeks after burst), we require a Band 3 observation with 1-sigma sensitivity of 0.03 mJy/beam, also amounting to 1 hour of on-source integration.

**In The Future:** The availability of more antennas will make it possible to carry out more sensitive observations enabling polarization observations which will provide valuable information on the jet-like outflow, which is the origin of the radio emission.

## Imaging CO Gas in a Nearby Starburst Galaxy

**Science Aim:** *Map the distribution and kinematics of molecular gas in a nearby starburst galaxy*

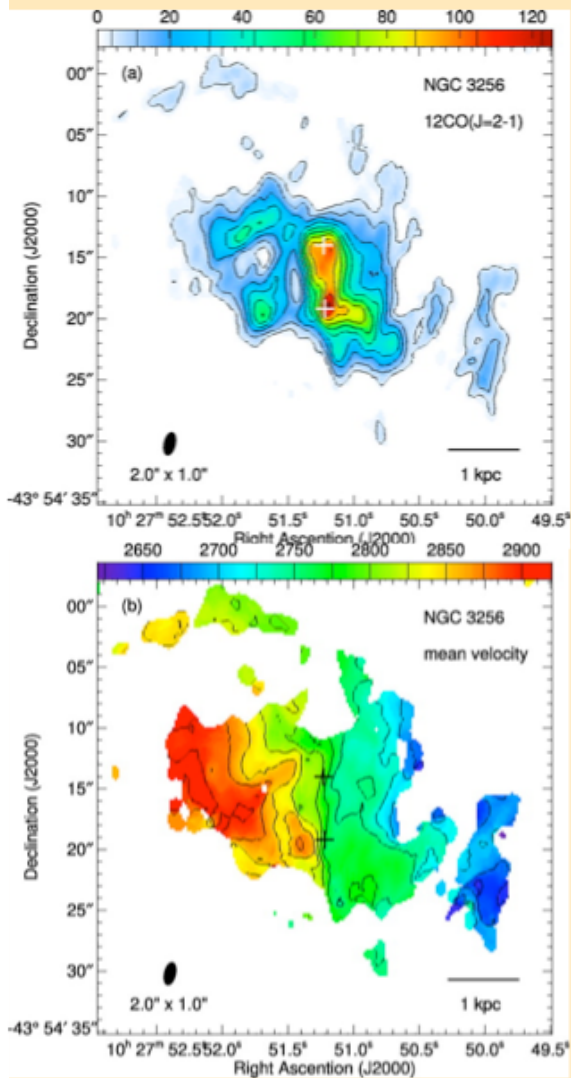

Figure 19: NGC 3256, a nearby luminous infrared galaxy, as imaged by the SMA (Sakamoto et al. 2006, ApJ, 644, 862). (Top) Integrated CO(2-1) intensity at  $2'' \times 1''$  resolution, (Bottom) mean velocity along each line of sight derived from the CO line. During Early Science, ALMA will be well suited to make comparable observations.

Merger-induced starbursts in luminous and ultraluminous infrared galaxies are visible out to cosmological distances. These starbursts tend to be compact ( $\sim 1$  kpc) and even the nearest such galaxies are still quite distant in absolute terms (tens of Mpc). As a result, relatively little is known about the physical conditions, dynamics, and detailed distribution of the star-forming gas and dust in these galaxies. Exploring these properties in nearby mergers is a natural application for submillimeter interferometers. ALMA's *Early Science* capabilities are well-suited to study the nearest such galaxies. Here we work through an example based on an SMA study of CO emission from NGC 3256 by Sakamoto et al. (2006, ApJ, 644, 862). Our basic goal is to map the intensity and kinematics of  $^{12}\text{CO}$  line emission across the galaxy using a small mosaic and image fainter, optically thinner  $^{13}\text{CO}$  emission in the central field.

**Receivers: Band 6 (230 GHz):** Molecular gas in starbursts tends to have fairly high excitation, making either CO (3-2) in Band 7 or CO (2-1) in Band 6 good probes of the gas. For this project, we elect to observe in Band 6, and request time to map the system in both  $^{12}\text{CO}$  (2-1) and  $^{13}\text{CO}$  (2-1).

**Angular Resolution:**  $\sim 0.68''$  with a maximum baseline of 400 m. We want to spatially resolve the bright central starburst region in NGC 3256, which is  $\sim 5''$  across. The primary beam for Band 6 (CO 2-1) is  $\sim 27''$ . To ensure that we also capture the extended emission in Figure 19, we will observe  $^{12}\text{CO}$  using a small 7-field mosaic: one field towards NGC 3256 with 6 adjacent fields arranged in a hexagonal pattern offset by half of the primary beam width. We will observe  $^{13}\text{CO}$  emission only from the central field, which contains most bright CO emission.

**Spectral Resolution:**  $\sim 1.3$  km/s (i.e., correlator mode 7). This will give us a detailed measurement of the line profile along each line of sight (FWHM  $\sim 25$ -150 km/s) and allow us the chance to pick out individual star-forming clouds (typical FWHM  $\sim 10$  km/s) by their spectral signatures.

**Channel (Line) Sensitivity:** 0.23 K at 1.3 km/s ( $^{12}\text{CO}$ ) and 0.02 K at 20 km/s ( $^{13}\text{CO}$ ): The SMA observed  $^{12}\text{CO}$  (2-1) intensities of  $>2$  K in 10 km/s channels at  $\sim 1.5''$  resolution, so we target a  $1\sigma$  sensitivity of 0.23 K per 1.3 km/s channel for SNR  $> 10$ . We also want to observe the optically thinner  $^{13}\text{CO}$  line. This requires a second tuning (a separate observation) and is often 5-10 times fainter than  $^{12}\text{CO}$ . We assume a typical line ratio of  $\sim 10$  and so target 0.02 K. If  $^{13}\text{CO}$  is unusually weak, as Sakamoto et al. actually found, we can improve the SNR by degrading the angular resolution. The  $^{12}\text{CO}$  data meet our kinematic goals so we target a lower spectral resolution of 20 km/s for the  $^{13}\text{CO}$  data.

**Continuum Sensitivity:** N/A: Continuum could easily be an aim of this project, especially if we had chosen Band 7, but we will not focus on it in this example except to say that any unused correlator resources can be put to good use observing the 1.3 mm (Band 6) dust continuum.

**Observing Requirements:** Putting in 16 antennas with the appropriate frequencies and spectral resolutions, the ALMA sensitivity calculator suggests that we need 7.6 hours on source to achieve 0.02 K for 0.7'' beam and a 20 km/s channel ( $^{13}\text{CO}$ ), and 47 minutes to achieve the 0.23 K per 1.3 km/s channel targeted for  $^{12}\text{CO}$  in an individual pointing. For the  $^{12}\text{CO}$  mosaic, we will target this depth for each pointing, yielding a total time request of 5.5 hours. During this time we will rotate between the fields to achieve matched, good  $uv$ -coverage. With a source this complex, it makes sense to use a Simdata simulation to estimate the  $uv$ -coverage required for a specific science aim. (Time estimates do not include overheads.)

**In The Future:** More antennas and longer baselines will make it possible to observe more distant systems at similar spatial resolution. Longer baselines also allow improved resolution to study the structure of this galaxy in more detail. However, increasing the angular resolution of our image while maintaining our surface brightness sensitivity will require increased observing time. Short spacing observations from the ACA and total power antennas would be useful for this kind of project and critical to study the dust continuum (which is not separated by velocity like the CO emission).

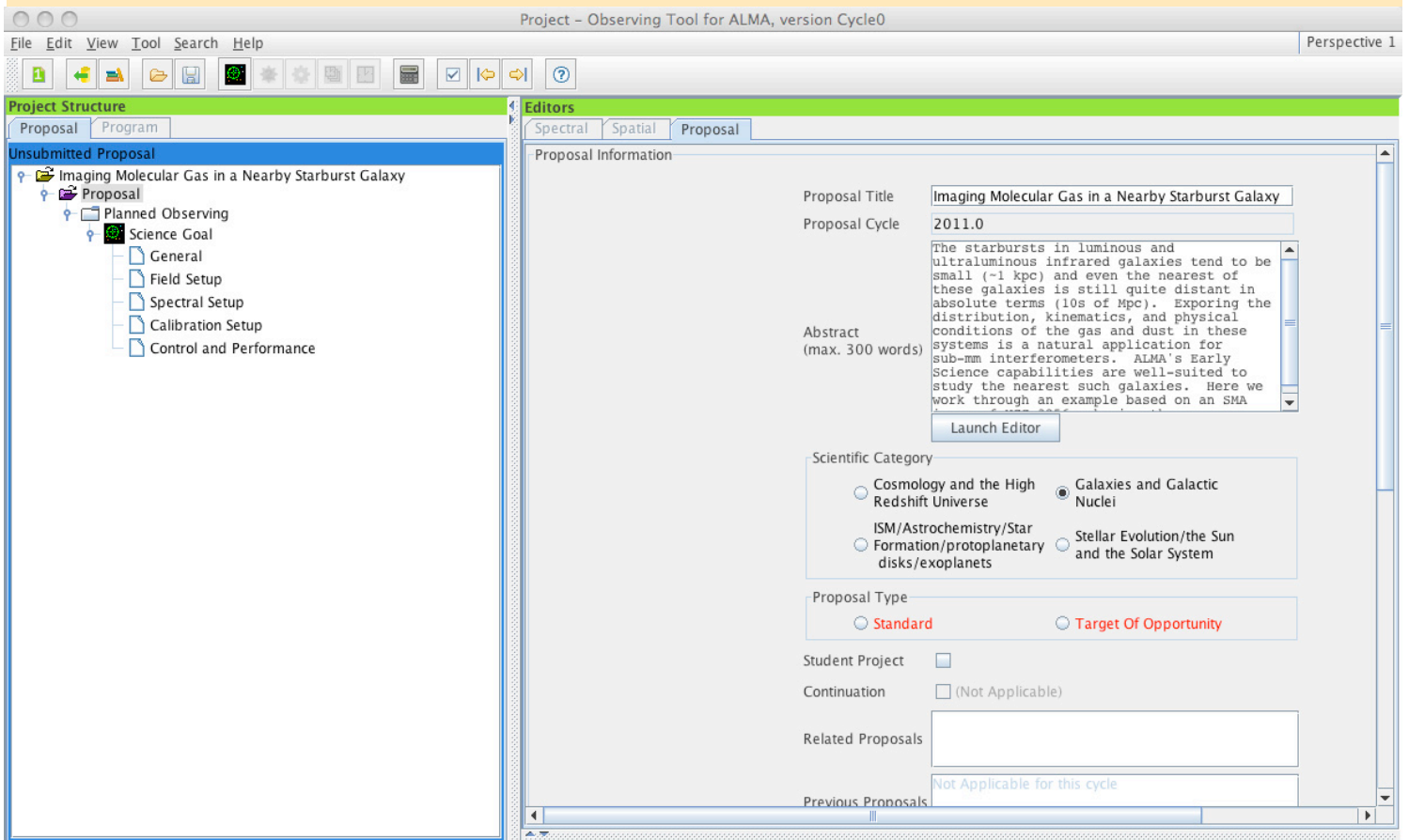

Figure 20: Screen shot of OT Proposal Screen. Here the user enters the title, abstract, and investigator list, selects the science category and provides other background information.

# Chemical and Evolutionary Diversity in a Massive Protostellar Cluster

**Science Aim:** *To observe the molecular chemistry and kinematics of the massive protostellar cluster NGC6334I*

When a massive star forms, photoionization of dust grains liberates complex organic molecules and leads to a “hot core” phase. Subsequent expansion of the ionized region leads to a detectable ultracompact HII region. In this target, objects in several phases of star formation appear to be present within 10000 AU of one another, in a configuration similar to the more evolved Trapezium cluster. ALMA will better reveal the kinematics toward the hot cores and will determine whether accretion structures are present. In addition, ALMA will evaluate which of the objects drive outflows, will detect dust emission from lower mass protostars, and will determine how these massive members affect the lower mass protostars in this active star-forming cluster.

**Receivers:**

**Bands 6 and 9 (220 GHz and 670 GHz)**

Band 6 is needed to understand the effects of dust opacity on the line emission from the hot cores, and Band 9 is needed for the highest angular resolution and to characterize the spectral index and dust emissivity. We will observe many useful molecules in both bands that provide temperature measurements including CH<sub>3</sub>CN, CH<sub>3</sub>OH, and C<sub>2</sub>H<sub>5</sub>CN, and shock tracers such as SiO and SO<sub>2</sub>.

The typical separation of massive protostars in this cluster is ~2000 AU, which is about 3'' for this source (d=1.6 kpc). As the hot core emission is smaller than 1000 AU, sub-arcsecond observations are needed to avoid loss of sensitivity due to beam dilution. The 0.7-0.8'' resolution can comfortably separate the sources, as well as avoid loss of sensitivity to the hot core due to beam dilution. The 28'' FOV at Band 6 is sufficient to cover the ~12'' region of interest in a single field (though primary beam correction will be important), but to cover it with the 9'' FOV at Band 9 will require a 7-point mosaic.

**Angular Resolution:** 0.7'' (Band 6 using 400 m max baseline), 0.8'' (Band 9 using 125 m max baseline). The typical separation of massive protostars in this cluster is ~2000 AU, which is about 3'' for this source (d=1.6 kpc). As the hot core emission is smaller than 1000 AU, sub-arcsecond observations are needed to avoid loss of sensitivity due to beam dilution. The 0.7-0.8'' resolution can comfortably separate the sources, as well as avoid loss of sensitivity to the hot core due to beam dilution. The 28'' FOV at Band 6 is sufficient to cover the ~12'' region of interest in a single field (though primary beam correction will be important), but to cover it with the 9'' FOV at Band 9 will require a 7-point mosaic.

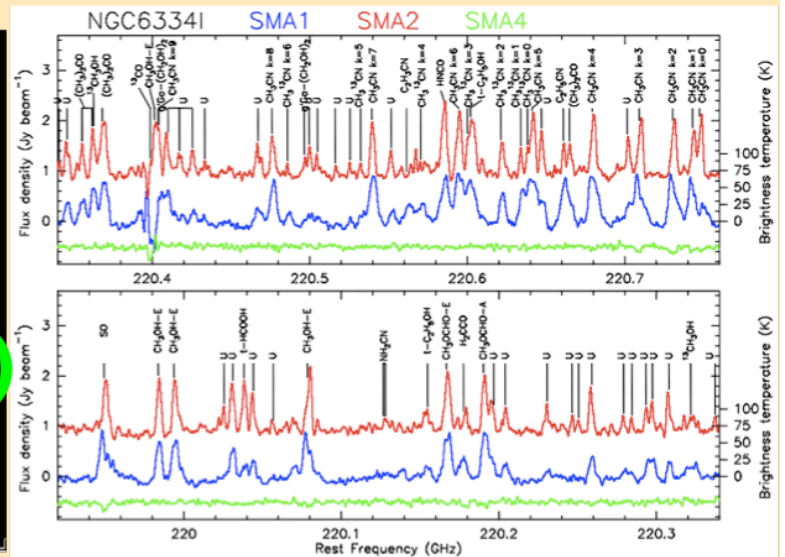
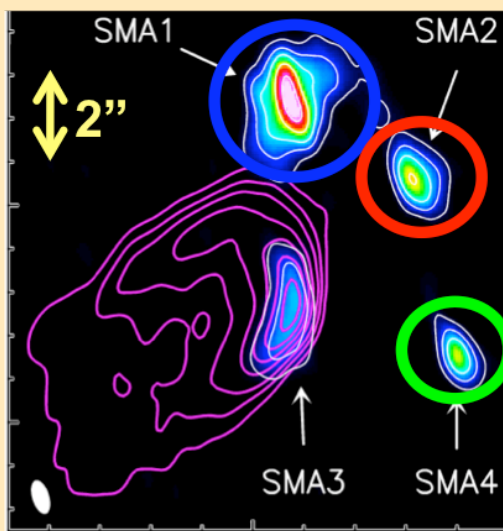

Figure 21: *Left:* Color-scale and white contours show a Submillimeter Array (SMA) continuum image at 1.3 mm (222 GHz) of NGC6334I (Brogan et al. 2011, in prep) with a resolution of ~0.5''. The magenta contours show VLA 3.6 cm continuum from a UCHII region. *Right:* Spectra of three of the sources showing the diversity of chemistry toward the protostars.

Learn More  
about the spectral line catalogue tool  
Splatalogue at  
<http://www.splatalogue.net/>

**Spectral Resolution:** The 230 GHz SMA observations have  $0.4 \text{ MHz} = 0.5 \text{ km/s}$  wide channels. Using *Early Science* correlator mode 8, we can get dual polarization and 1.875 GHz bandwidth in each sideband with 0.244 MHz (0.33 km/s) channels in Band 6, which will yield an effective velocity resolution of 0.66 km/s. For Band 9, using this mode will yield 0.11 km/s channels (0.22 km/s resolution). The latter data will be smoothed offline in velocity by another factor of two for  $\sqrt{2}$  better sensitivity.

**Sensitivity and Observing Time:** The 230 GHz SMA spectra have 40 mJy/beam rms. Using the ALMA sensitivity calculator with sixteen 12 m antennas, dual polarization and  $\sim 0.5 \text{ MHz}$  velocity resolution, these point source sensitivities can be achieved at the center of the field in only 58 seconds at Band 6 and 2.9 hours for one field at Band 9 (assuming extra velocity smoothing for the latter). With half-beam sampling of the mosaic, the time needed to reach this sensitivity with 7 overlapping fields is about  $2.9 \text{ hrs} * 7 = 20.5 \text{ hours}$  in Band 9 (not including overheads). Note that this mosaic will not be sensitive to smooth structures larger than about  $3''$  without the ACA compact array and total power data (not available during *Early Science*), but the individual NGC6334I cores fit comfortably within this limit. Although the required sensitivity suggests a time of only 58 seconds is needed at Band 6, we will need to approach the  $uv$ -coverage of the SMA data to get adequate image fidelity. Taking into account the difference in the number of baselines between the two arrays, this implies that we will need about 1.5 hours of hour angle coverage at Band 6. (Increased  $uv$ -coverage must be justified in the technical justification of the proposal, and flagged in the OT on the "Control and Performance" window (see fig. 24).) Since both bands will have line-free areas, the continuum sensitivity will correspond to a substantial fraction of the total bandwidth for continuum RMS noise levels of about 0.05 mJy/beam at Band 6, and 0.3 mJy/beam in Band 9. These relative sensitivities provide a good match to the typical spectral index of dust emission and will enable detections of the low-mass protostars associated with the cluster.

**In The Future:** As ALMA's maximum baseline length increases, the cores in this example can be better resolved at all wavelengths, and with matched angular resolution. Band 3 data at the same resolution of the  $0.8''$  Band 9 data would look for free-free emission and the presence of hypercompact HII regions,

but that will need to wait for baselines of  $\sim 1.5 \text{ km}$ .

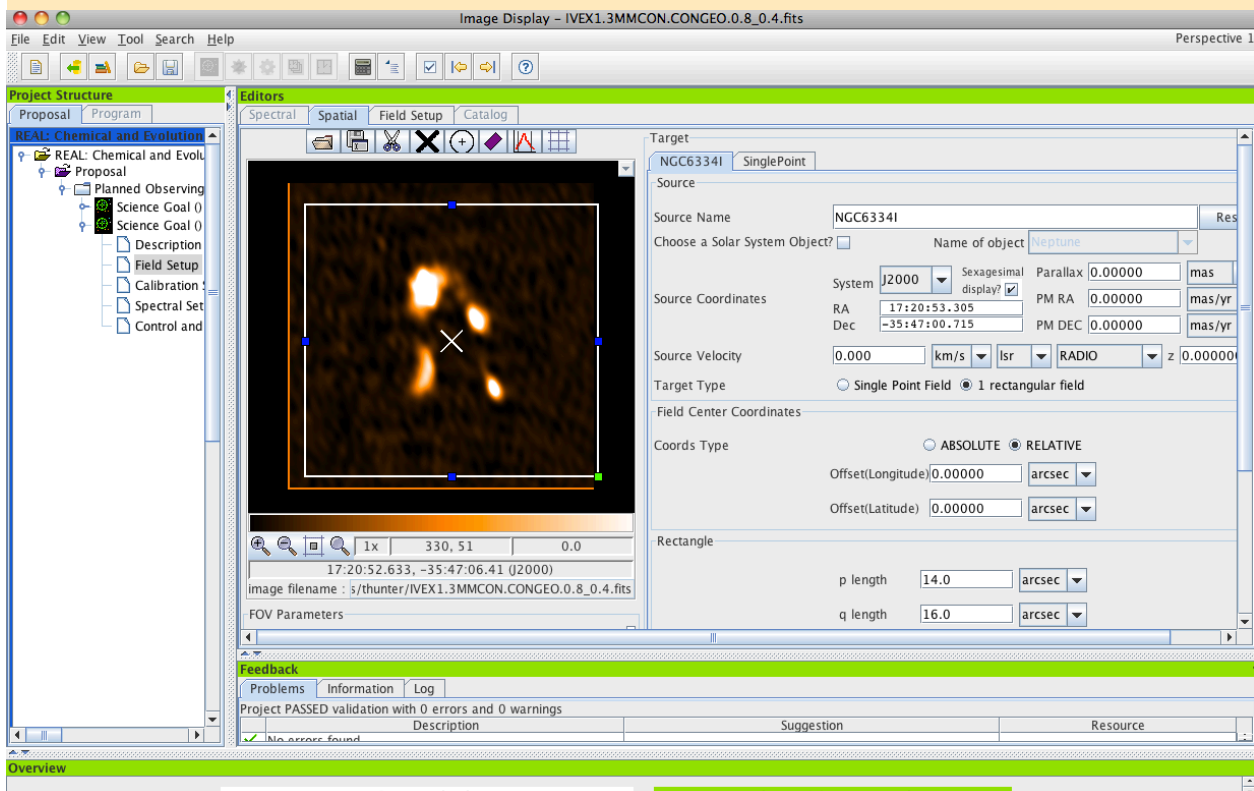

Figure 22: Screen shot of OT Spatial Editor for Field Setup. An existing fits file has been loaded and the proposed mosaic rectangle is superimposed.



## Multi-wavelength Continuum Survey of Protostellar Disks in Ophiuchus

**Science Aim:** *To observe the variation in the dust spectral energy distribution (SED) between protostellar disks in the nearby Ophiuchus molecular cloud*

The characteristics of dust in a disk around a protostar are expected to evolve over time, as dust grains settle to the disk mid-plane, accumulate into larger solid bodies, and potentially form planets within the disk. The evolution of the disk may be traced by determining the dust SED of a coherent sample of protostellar disks. Wide frequency coverage is necessary to achieve these aims, since the SED of the disk is determined by a combination of the dust temperature, the dust emissivity properties, and the optical depth through the disk. Nearby protostellar disks will not be resolved by ALMA at all frequencies during *Early Science*, but the *Early Science* collecting area will allow high sensitivity observations of the disk-averaged SED in a short observation. Here we present a proposal to observe 6 Class II protostellar disks selected from the catalogue presented by Evans et al. (2009, ApJS, 181, 321)

**Receivers: Bands 3, 6, 7 and 9:** (110 GHz, 230 GHz, 345 GHz and 690 GHz)

**Angular Resolution:** 0.23" (Band 9) to 1.4" (Band 3): This assumes a maximum baseline of 400 m. The typical size of a protostellar disk is  $\sim 100$  AU. Towards the nearest molecular clouds, such as Ophiuchus (at 125 pc), 100 AU subtends only 0.8", and may only be resolved in Band 9 during *Early Science*. Here we will focus on the global properties of the disks.

**Spectral Resolution:** N/A: Each measurement will include the largest bandwidth possible.

**Sensitivity and Observing Time:** We calculate the expected brightness of a typical disk assuming a disk mass of  $0.01 M_{\odot}$ , an average dust temperature of 20 K, a plausible dust emissivity and a distance of 125 pc. The fluxes we expect are 4, 30, 80 and 400 mJy for bands 3, 6, 7, and 9, respectively. To get  $10 \sigma$  detections, the point source sensitivity needed would be 0.4 mJy/beam, 3 mJy/beam, and 8 mJy/beam for Bands 3, 6, and 7, respectively. In Band 9, where the disks are likely to be a few times the size of the beam, the sensitivity for a  $10 \sigma$  detection in each beam should be roughly 10 mJy/beam. Using the ALMA sensitivity calculator with sixteen 12-m antennas and 7.5 GHz bandwidth per polarization (dual polarization), these point source sensi-

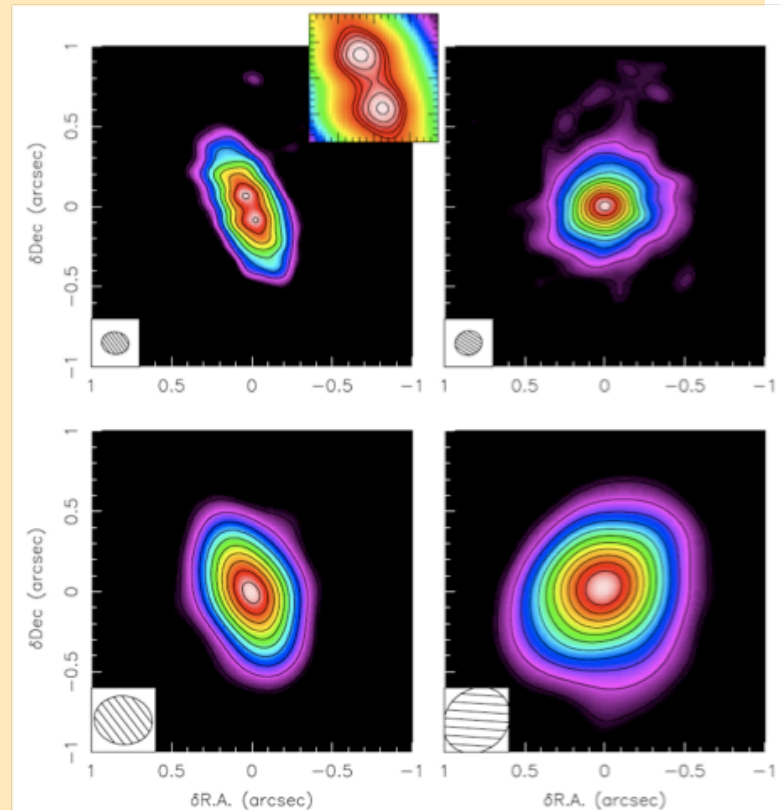
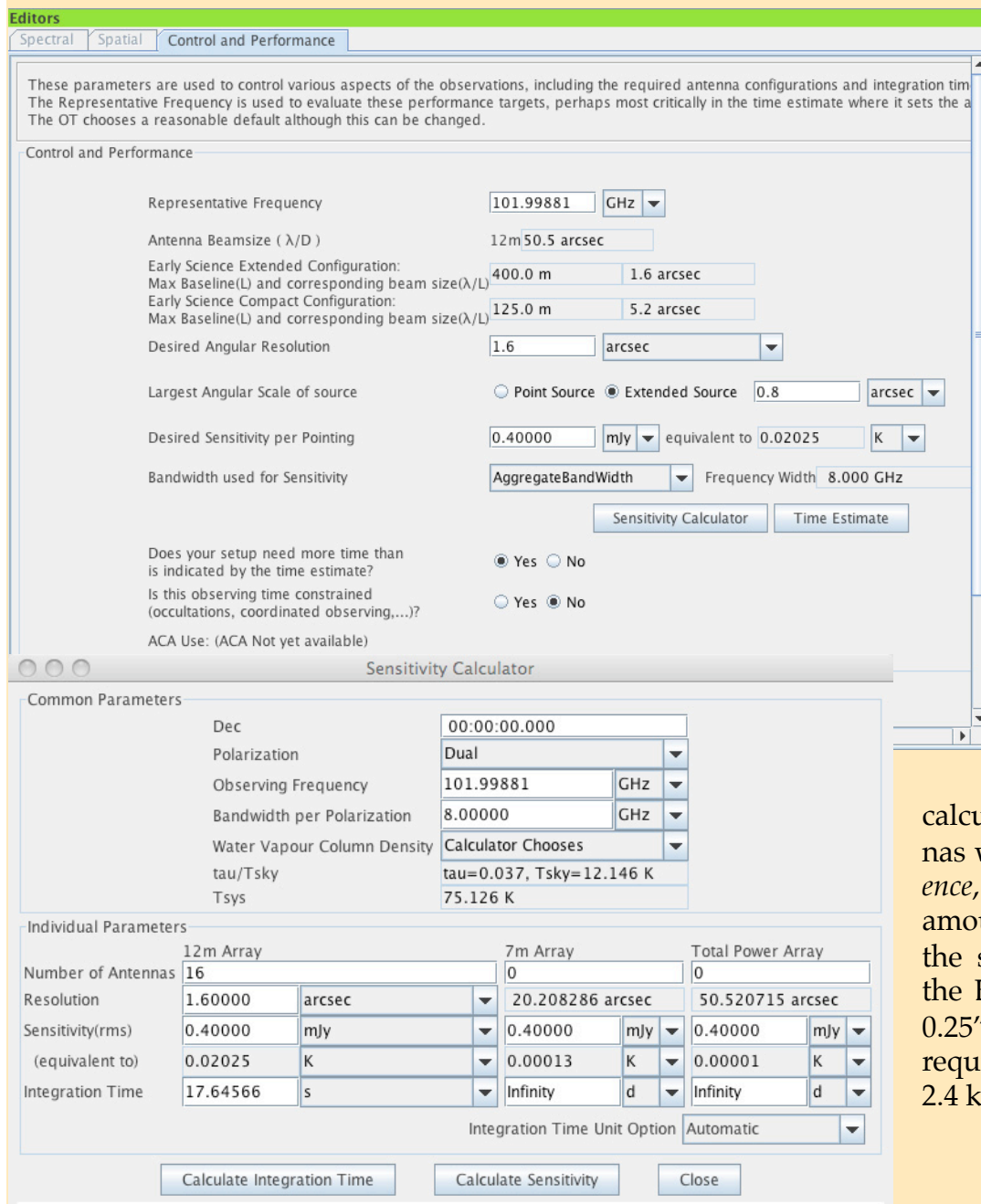

Figure 23: **Top:** CARMA aperture synthesis images of 1.3mm (228 GHz) continuum emission from two protostellar disks in Taurus with an inset to highlight the double structure seen in the top left panel (Isella et al. 2010, ApJ, 714, 1746). **Bottom:** CARMA images of the 2.8mm (106 GHz) emission from the same two disks (Isella et al.). Each image includes  $\sim 8$  hours of data for each of several different CARMA configurations, for a synthesized beam of  $\sim 0.15''$  FWHM at 1.3mm and  $\sim 0.4''$  at 2.8mm. During *Early Science*, ALMA will achieve  $\sim 0.4''$  angular resolution in Band 9 (690 GHz) with similar *uv*-coverage to CARMA for a given observing time. The sensitivity of ALMA during *Early Science* will be better (for a given observing time) due to increased collecting area and continuum bandwidth.

ties can be achieved in 21 s per disk (Band 3), 0.7 s per disk (Band 6), 0.3 s per disk (Band 7) and 23 s per disk (Band 9). (Time estimates do not include overheads.)

**Observing Requirements:** As shown in Figure 11, the sensitivity (even to a point source) is improved by a range of  $uv$ -coverage, especially in *Early Science*. At bands 3 and 6, where we expect the disks to be unresolved, we would therefore request a total of 1 hour of observations, interleaving all six sources to obtain greater  $uv$ -coverage. In bands 7 and 9, where the disks are more likely to be resolved, we want to obtain similar  $uv$ -coverage to the CARMA observations in the above Figure 23. Therefore, we would request  $uv$ -coverage spread over 8 hours of LST, with the sources interleaved. (Increased  $uv$ -coverage must be justified in the technical justification of the proposal, and flagged in the OT on the “Control and Performance” window (see fig. 24).) Note that the sources can be interleaved in these observations because they are close enough in the sky to share common calibrators.



**In The Future:** As ALMA's maximum baseline length increases, the disks in this example can be resolved at all wavelengths, with matched angular resolution. With greater angular resolution, the science case presented here can be expanded to study the variation of the dust SED as a function of disk radius, and to look for holes in emission, which may indicate the presence of gaps in the disks. The resolved disks will require a greater amount of observing time, for sensitivity (using the surface brightness rather than point source mode with the ALMA sensitivity calculator). The number of antennas will increase during *Early Science*, however, reducing the amount of time required to obtain the same  $uv$ -coverage. To match the Band 9 angular resolution of 0.25" discussed above at Band 3 requires a maximum baseline of 2.4 km.

Figure 24: **Top:** Screen shot of OT Control and Performance parameters. **Bottom:** OT Sensitivity Calculator

## Continuum and CO J=3-2 Emission from the Pluto-Charon System

**Science Aim:** *To observe the CO line on Pluto and to measure the fluxes of both Pluto and Charon:*

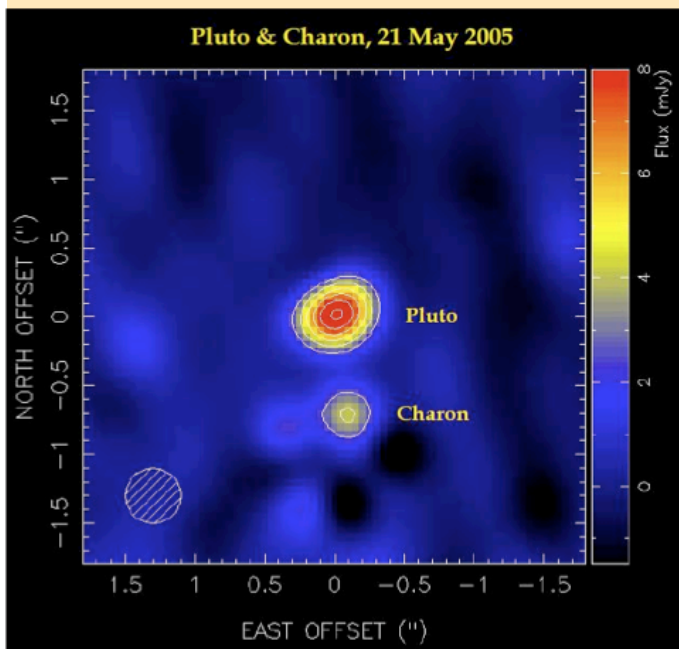

Figure 25: Submillimeter Array (SMA) aperture synthesis images of 1.4 mm (220 GHz) continuum emission of Pluto and Charon (Gurwell & Butler. 2005 BAAS 37, 743). These observations were made with the most extended SMA configuration during an 8 hour track, achieving a synthesized beam of  $\sim 0.4''$  FWHM. ALMA during Early Science will achieve similar angular resolution in Band 9 (690 GHz) with integration times of  $\sim 1$  hour.

$N_2$  is the dominant atmospheric molecule on Pluto, but the minor species of methane and CO dominate the thermal balance as they have a spectrum which better permits radiative activity, particularly when Pluto is closest to the Sun. Methane observations suggest an atmospheric temperature considerably warmer ( $\sim 100$  K) than the surface ( $\sim 45$  K) but CO has not been detected. The proposed ALMA ES observations will constrain atmospheric models; the New Horizons spacecraft will provide in situ measurements during its 2015 flyby. These observations will also constrain the surface temperature of both bodies.

**Receivers: Bands 7 and 9:** (345 GHz and 690 GHz)

**Angular Resolution:**  $0.25''$  (Band 9) to  $0.5''$  (Band 7): This assumes a maximum baseline of 400 m. The typical separation of Pluto and Charon is  $\sim 0.9''$  so the two will be well-resolved at 690 GHz but barely so at 345 GHz.

**Spectral Resolution:** To resolve the expected 1 km/s line width for CO (3-2) requires a spectral resolution of about 0.2 km/s, so we will use correlator mode 9 at Band 7 (345 GHz) with 0.106 km/s channels, yielding a spectral resolution of 0.21 km/s. For the continuum at Bands 7 (345 GHz) and 9 (670 GHz), we will use mode 69 (dual polarization) to maximize sensitivity.

**Continuum Sensitivity:** 0.8 mJy/beam and 2 mJy/beam for Bands 7, and 9, respectively: Pluto should have flux densities of 20 and 100 mJy respectively at the two frequencies, while Charon will be 40% of those values. The sensitivity required for  $50\sigma$  detections of Charon will be 0.16 mJy/beam and 0.8 mJy/beam. These levels may be reached in 13 minutes and 1 hour for Bands 7 and 9, respectively.

**Channel (Line) Sensitivity:** 10 mJy km/s in Band 7: The predicted intensity of the CO (3-2) line from Pluto ranges from about 50 to 120 mJy in a 1 km/s line. By comparison, the CO (6-5) line is expected to be 10 times weaker, and thus observations of it will need to await Full Science.

**Observing Time:** Using the ALMA sensitivity calculator with sixteen 12 m antennas, and dual polarization, the Band 7 CO (3-2) spectral line observations, reaching a 22.3 mJy rms in 0.21 km/s resolution elements, require 21.7 minutes of observing time. To reach the continuum sensitivities with 8 GHz of bandwidth and dual polarization at Bands 7 and 9 will require 0.22 and 1 hour of exceptional weather, respectively. Pluto is well-placed for winter observation. (Time estimates do not include overheads.)

**In The Future:** As ALMA's maximum baseline length increases, all the moons in this example can be resolved at the shortest wavelengths. Other CO lines may be measured in order to put better constraints on the atmospheric structure. Increased sensitivity will enable the array to detect Nix and Hydra, pro-

viding good estimates of the size and density of these enigmatic moons. Also, better orbital parameters will help to guide the New Horizons spacecraft during its 2015 encounter with the Pluto system.

Figure 26: Screen shot of OT showing the Spectral Setup Visualization Tool for the Pluto/Charon example.

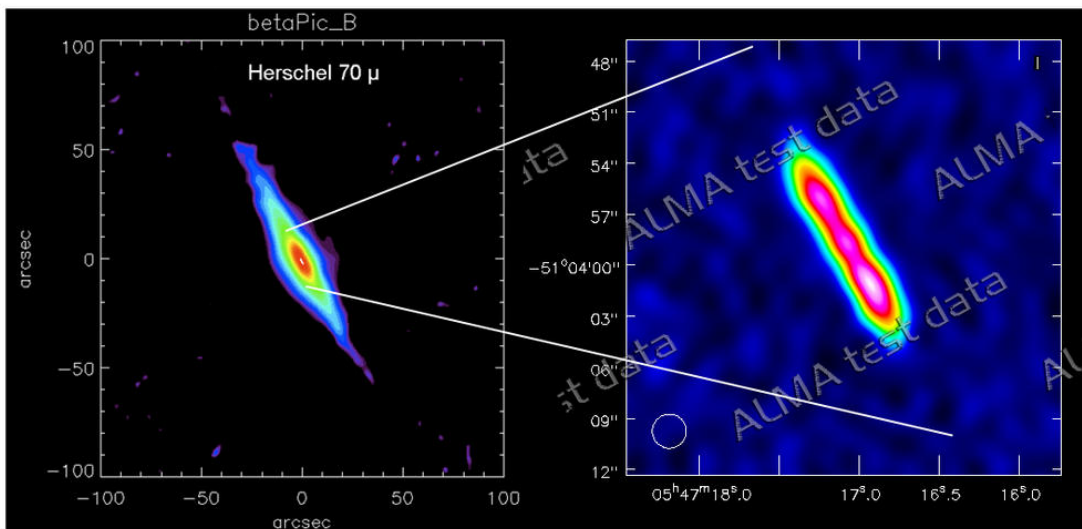
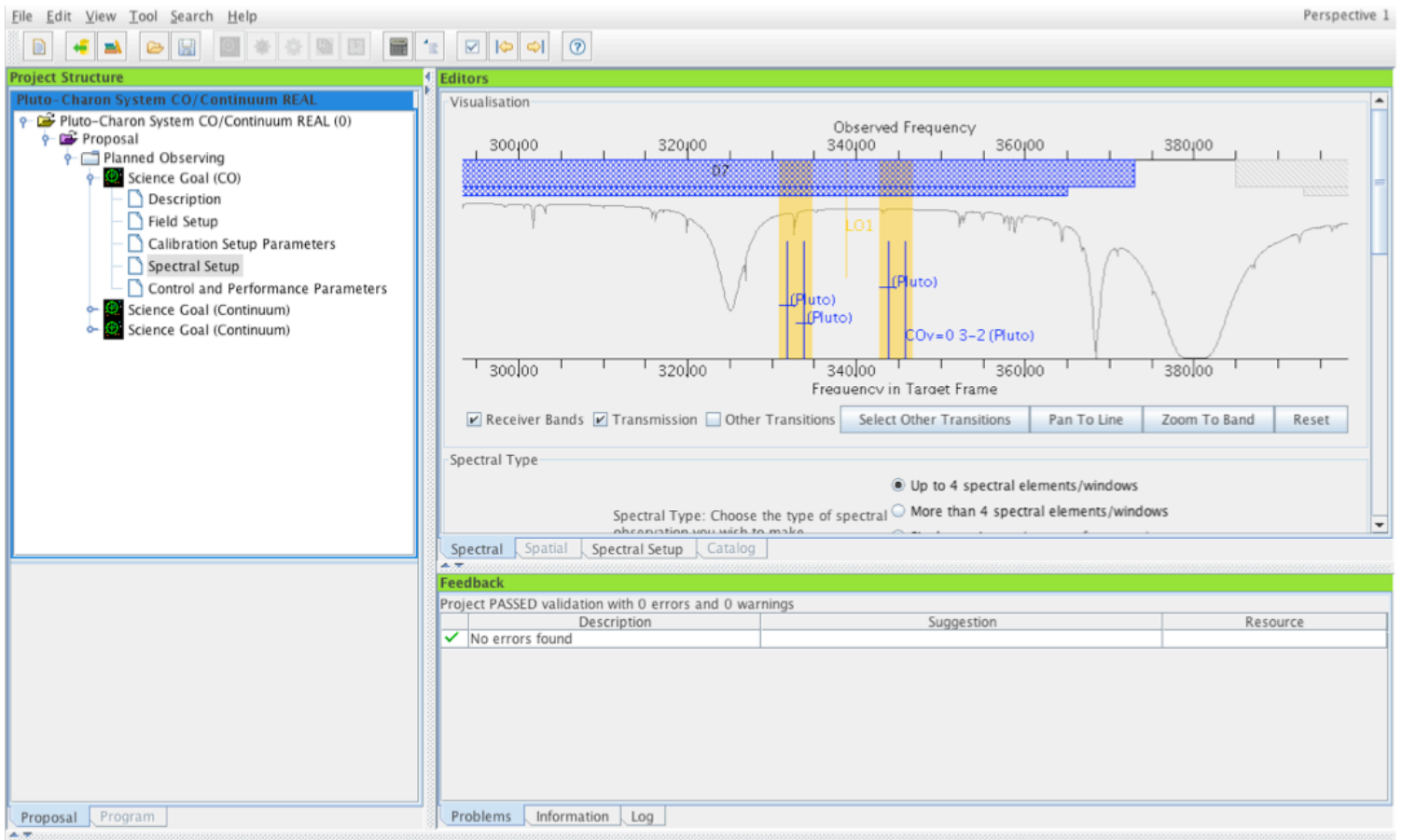

Figure 27: ALMA Test Data (Nov 2010). Emission from the debris disk surrounding the star Beta Pictoris. On the left is a 70 $\mu$ m image from Herschel, (Olofsson et al., SDP Presentations, Madrid, Dec 2009) and on the right is the ALMA test data at 870  $\mu$ m (Band 7) showing the denser material in the central region. © ALMA (ESO/NAOJ/NRAO)

# Observations and Data Reduction\*

## Proposal Submission and Observing Process

A users-view of the ALMA observing program workflow, from the Call for Proposals through data delivery, is given in Figure 28. Each column separates actions out by who is performing the action: the User, the local ARC, or the DSO. This section briefly describes the workflow, and the various software tools used at each stage. Subsequent subsections tell where to find the tools and any supporting documentation, and list any platform or operating system requirements.

**Call for Observing Proposals:** The general procedure is that the DSO generates the text for the Call for Proposals (CfP), which includes the anticipated capabilities of the observatory (available observing bands, correlator modes, observing modes, configurations, etc.) for the upcoming observing season. The first Call for *Early Science Proposals* (Cycle 0) was issued March 31, 2011 with deadline June 30, 2011.

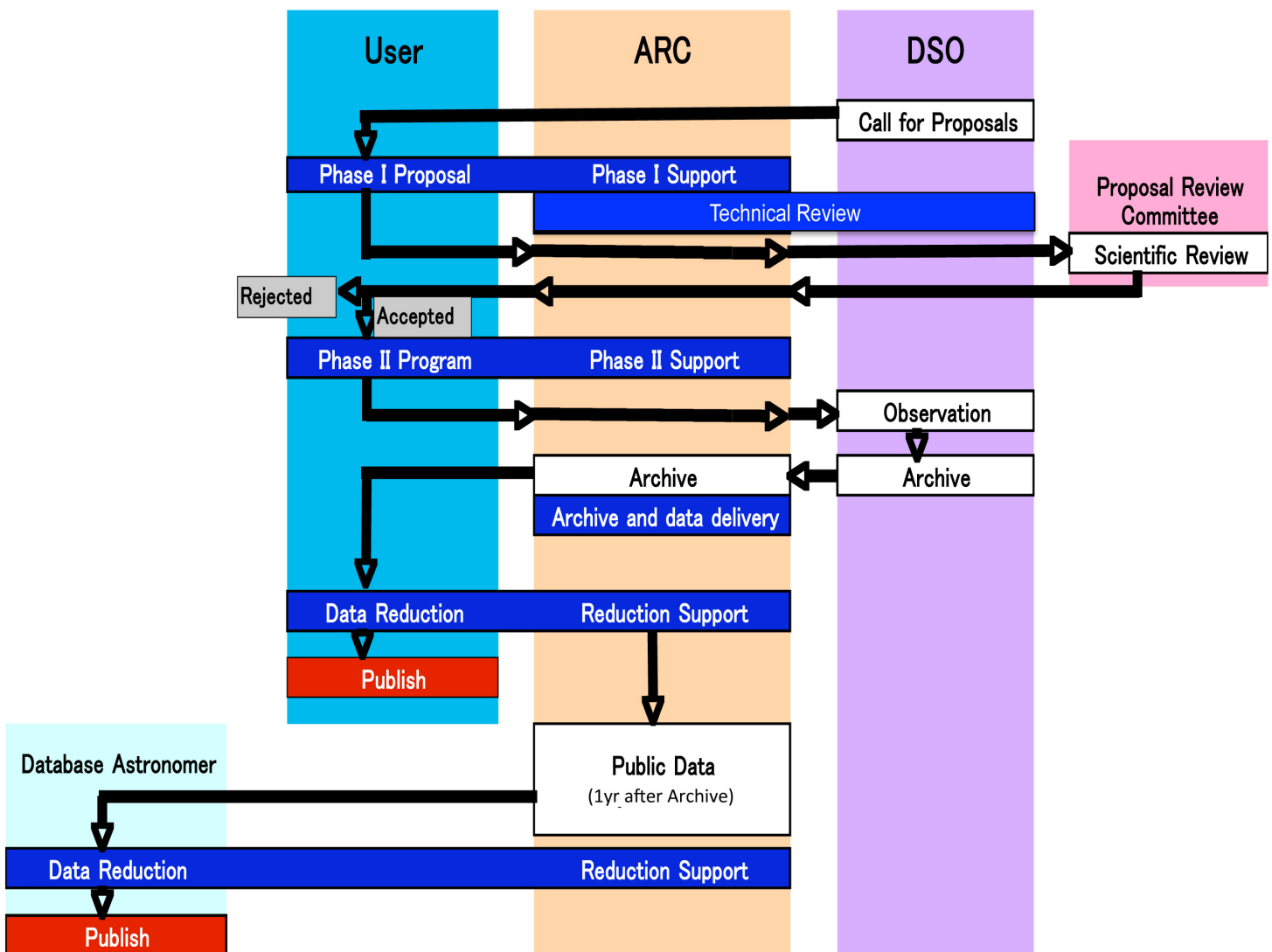

Figure 28: Schematic showing the various steps and support available for proposal generation, acceptance, and observation. The ALMA Department of Science Operations (DSO) will make the call for proposals and the ALMA Regional Centers (ARCs) will support the user in schedule block (SB) generation, observation, and reduction. The ALMA Project will also maintain an archive of all ALMA observations.

\*For the non-expert reading this section, a list of Interferometer Concepts is included on page 37.\*

The CfP will be broadcast to the regional and worldwide communities by the ARCs using standard broadcasting means (e.g. society and observatory newsletters and mailing lists), and will be posted to the ALMA science websites.

**Registering as an ALMA User:** All users who wish to be part of any ALMA proposal (either as Primary Investigator or Co-Investigator), to submit tickets to the ALMA Helpdesk, to track a project, or to retrieve data from the ALMA Science Archive must register as an ALMA user via the ALMA Science Portal (see link page 41). Non-registered users may still access ALMA user tools, software, or browse the science archive.

Users will be associated with one of the ALMA partners (EU, NA, EA, or Chile) or as being outside the partnership based on their institutional affiliation(s). This affiliation factors into time allocation and specifies the ARC portal users will be directed to for data retrieval and helpdesk support. Users from non-ALMA member regions or Chile may select any of the three ARCs for support.

**Proposal Preparation & Submission (Phase I Proposal):** After the CfP is issued, users will have some period (2-3 months) to prepare their Phase I materials using the ALMA OT. The OT is a java-based application based on existing tools for other observatories (Gemini, JCMT, Spitzer, Herschel), so its design should be familiar to many potential observers. Phase I consists of a detailed observing proposal with a scientific and technical justification submitted to the Observatory through the OT. The OT includes calculators for determining sensitivities, and viewers for assisting with correlator setups and mapping parameters, in order to prepare Science Goals. Users can use the ALMA Helpdesk, available from the ALMA Science Portal, to get assistance from ARC staff at any stage of the preparation and submission process (Phase I Support).

If desired, one can simulate ALMA observations using the *Simdata* tasks of the CASA software package, or using the web-based ALMA Observers' Support Tool. These tools take a model image as input and simulate the resulting ALMA image, accounting for the array configuration, instrumental noise, atmospheric phase delay, as well as the data reduction process. (See the examples in Figure 11.) One can also use the compilation of molecular spectral line databases provided by the *Splatalogue* on-line catalog to help plan spectral line observations.

**Proposal Review Process:** Phase I submissions will be peer-reviewed by a single international committee that is divided into a number of science-themed review panels (Scientific Review). Time will be awarded based on the proposals scientific ranking and available time. The time available for projects will depend on the PI's institutional affiliation, with [33.75%, 33.75%, 22.5%, 10%] made available to projects associated with the North American, Europe, East Asian, and Chilean partners, respectively. A certain amount of time may be made available to projects from non-ALMA member regions. Users should consult the ALMA websites and Call for Proposals for details. Users will receive notification of the proposal review process via email.

**Phase II Program:** During Phase II, successful proposers will use the OT to convert their Phase I Science Goals into a series of blocks of observing time called Scheduling Blocks (SBs). SBs will be submitted to a scheduling queue so they are available to the array operators when conditions are appropriate at the ALMA site, according to the ranked list of proposals, operations schedule and weather conditions. Again, the ARCs are available to help observers through the Phase II process (Phase II Support). Once SBs have been submitted, users will be able to track the status of their project through the ALMA Project Tracker, a user application available from the Science Portal.

**Archive & Data Delivery:** After all SBs associated with a science target have been successfully observed, the data will be processed and quality assured by ALMA staff and deposited into the ALMA Sci-

Learn More

The OT is accessible from

<http://almascience.org/>

ence Archive, where they may be retrieved by observers. ALMA data have a one-year proprietary period from the date when they are placed in the ALMA Science Archive and made available to the PI. Archived data products include the raw visibilities, telescope logs, relevant data reduction scripts, and reference images and cubes.

## Observing Considerations

While considering a possible ALMA project, it is important to understand that ALMA is a very flexible instrument. Data can be obtained over a wide range of observational parameters: angular resolution, field-of-view, spectral resolution, and sensitivity. These quantities must be specifically defined and justified for a given project in a proposal, and careful choices are required to ensure that the project's scientific aims can be met. These quantities are also used during Phase II, to guide in planning the execution of the project. Depending on the nature of a given project, the observational parameters may be interrelated. In the following, we describe the basis for choosing these parameters.

**Learn More**

Go to  
<http://www.aoc.nrao.edu/events/synthesis/2010/lectures10.html> to find out more about the fundamentals of interferometry.

**Angular resolution** (or “synthesized beam”) is the minimum angular separation whereby adjacent spatial features can be distinguished. Angular resolution fundamentally varies as the inverse of the product of observational frequency and distances between the antennas used to make the image; higher frequencies or longer antenna baselines result in data of finer angular resolution. An important concept to remember about interferometers is that they can only observe emission on a discrete set of spatial scales (i.e., spatial frequencies), as measured by the antenna pairs making up an array (see “*uv*-coverage”, page 38). Since the number of spatial scales measured is finite, the resulting image is spatially “filtered” and only reflects the emission on the observed spatial scales. Even for a given baseline distribution, however, the observer has some control over the effective resolu-

tion. An important concept to remember about interferometers is that they can only observe emission on a discrete set of spatial scales (i.e., spatial frequencies), as measured by the antenna pairs making up an array (see “*uv*-coverage”, page 38). Since the number of spatial scales measured is finite, the resulting image is spatially “filtered” and only reflects the emission on the observed spatial scales. Even for a given baseline distribution, however, the observer has some control over the effective resolu-

Figure 29: ALMA Test Data (Nov. 2010). An example of ALMA's potential as a spectroscopic instrument: on the left is the map of the molecular “hot core” G34.26+0.15, which is unresolved with the short baselines that were used, whereas a section of the spectrum near 100 GHz (Band 3) shows a “forest” of molecular lines. © ALMA (ESO/NAOJ/NRAO).

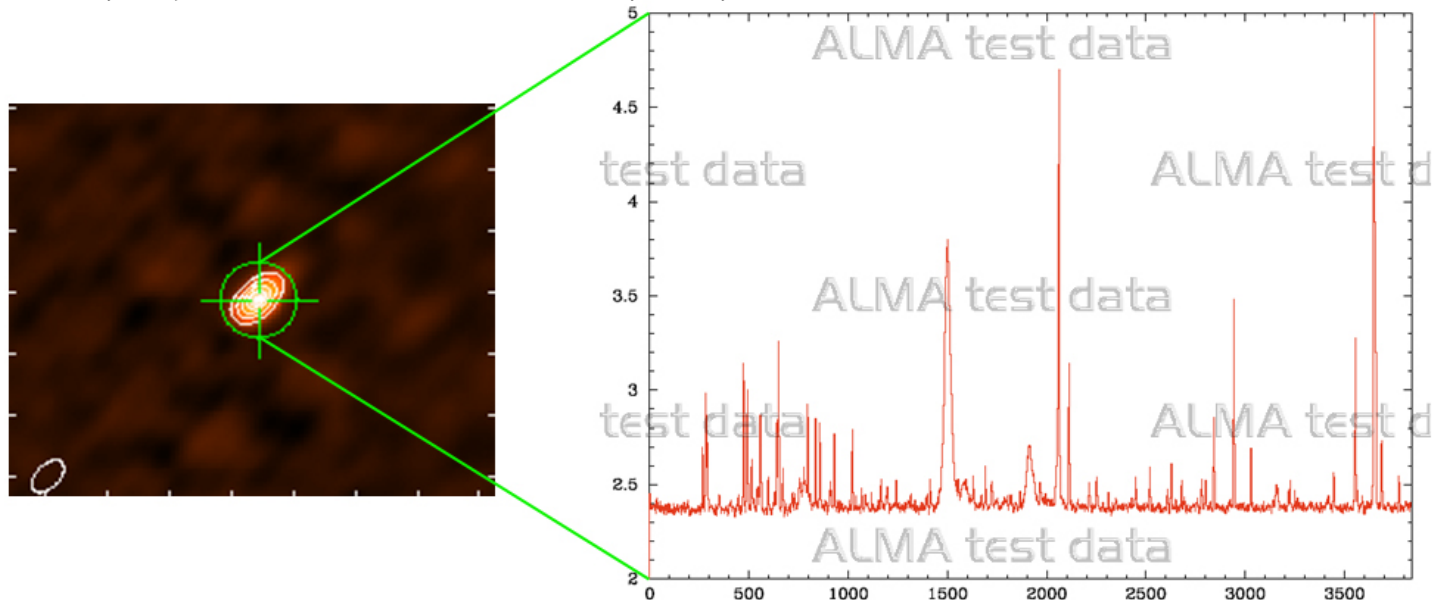

tion of the image during post-processing. By using different weighting schemes to reconstruct an image, it is possible to make moderate tradeoffs between effective resolution and surface brightness sensitivity.

**Maximum Scale** (or largest observable scale) is defined to be  $0.6 \times (\text{wavelength}/\text{minimum baseline})$  and is a guideline for the largest angular scale on which most of the flux of a smooth structure can be reasonably recovered by the interferometer. This rule-of-thumb applies to the size scale of smoothly varying structures in both dimensions. Smooth structures larger than  $\sim 1.0 \times (\text{wavelength}/\text{minimum}$

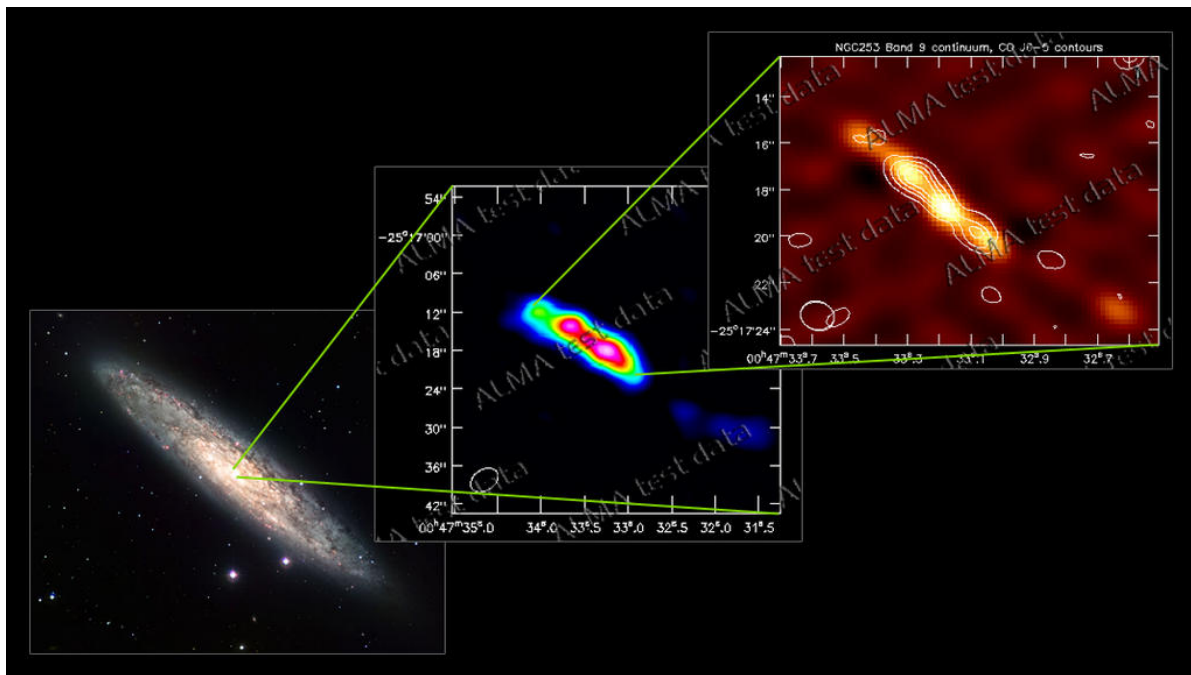

Figure 30: ALMA Test Data (Nov. 2010). The well-known spiral NGC253, with an optical image of the whole galaxy on the left (credit: ESO). The ALMA test images show dense clouds of gas in the central regions of the galaxy: (middle) the CO J = 2-1 line at 230 GHz (Band 6) and (right) the continuum and CO J = 6-5 line at 690 GHz (Band 9). © ALMA (ESO/NAOJ/NRAO).

baseline) will be "resolved out" by the interferometer. This is the well known "missing flux" problem intrinsic to interferometry. The minimum baseline depends both on the array configuration (i.e. compactness) and source elevation. To recover emission that has been "resolved out," additional observations are needed, including observations with more compact arrays with smaller-sized antennas (such as the ACA) or large single-dish telescopes (ALMA will have four specially outfitted 12m antennas, the TPA, that can be used to sample large-scale emission by scanning over fields in a non-interferometric, "total power", mode). One can explore with the ALMA simulator (Simdata) in CASA whether the ACA will be required for a particular project, and the ACA can be requested in the proposal at Phase I. Note, however, that the ACA and TPA will not be available for *Early Science*.

**Field-of-view** (FOV) is the area on the sky over which an interferometric image is obtained. The instantaneous FOV is formally the angular size of the half-power width of the Gaussian beam (FWHM) of the individual antennas and is also called the width of the "primary beam". The size of the FOV depends on the inverse of the product of the frequency of the observation and the diameter of the individual antennas used; larger antennas or higher frequencies result in smaller FOVs. For a single pointing, the sensitivity of the observation is not uniform across the FOV; it declines with angular separation from the center position with the approximately Gaussian responsivity of the main antenna beam. Larger FOVs and flatter map sensitivities across images can be attained by observing in series many adjacent locations on the sky (best separated by  $\lambda/2D$  where  $\lambda$  is the observed wavelength, and  $D$  is the diameter of the antennas, to achieve Nyquist sampling) and using the resulting data to create a "mosaic" map. Note, however, there will be only limited mosaicing (maximum 50 pointings) available for *Early Science*.



To have constant sensitivity across the mosaic, each pointing must be observed to the same relative sensitivity. Thus, mosaics can be quite costly in terms of observing time. Deciding whether a mosaic or a single pointing should be observed requires an understanding of the expected source structure and size, i.e., whether or not the observed emission will be extended, based on previous data from other telescopes. Furthermore, if multi-band images over the same FOV are needed for a given project, mosaics may be required with higher frequency bands in order to match the area coverage of a single pointing with lower frequency bands. Mosaics can also aid in recovering some emission on scales larger than those that are sampled by single pointings, though they cannot compensate for emission that has been “resolved out”. (See Maximum Scale above.)

**Spectral resolution** is the minimum separation in frequency whereby adjacent independent features can be distinguished. The digitized data from ALMA allows for an incredible range in spectral resolution, although the range available will be somewhat limited during *Early Science*. (See page 9 for a table showing the correlator modes available during *Early Science*.) Spectral resolution depends on how the correlator has been configured. ALMA's correlator can be configured to provide data cubes with up to 8192 independent spectral channels. The width of these channels can be defined from 3.8 kHz to 25 MHz. For continuum observations, low spectral resolution (i.e., large total bandwidth) channels are averaged to achieve high sensitivity; the total bandwidth of all correlator settings used cannot exceed 7.5 GHz. For line observations, high spectral resolution (i.e., small bandwidth) is used to achieve high velocity resolution. Note that the velocity resolution of ALMA will be 2 x the channel spacing, assuming default Hanning data smoothing. For example, a 0.02 km s<sup>-1</sup> velocity resolution can be achieved for <sup>13</sup>CO 1-0 at 110 GHz by utilizing the narrowest channels (3.8 kHz). There is, however, a cost to sensitivity in using small bandwidth channels. Sensitivity can be improved after the observations by averaging channels together, i.e., by the inverse square root of the number of channels averaged, but at the expense of the spectral resolution. The ALMA correlator is highly complex and extremely flexible and can be configured to observe simultaneously several spectral lines within the 7.5 GHz band at high spectral resolution while additional correlator channels can be simultaneously used to observe continuum emission at low spectral resolution. In addition, a combination of high and low resolution correlator windows can be chosen over the same bandwidth to determine how emission from lines at these frequencies is contributing to the emission observed at low spectral resolution. Note, however, that these “mixed modes” of simultaneous narrow and wide bandwidth (i.e. high- and low-resolution) correlator settings will not be available during *Early Science*.

**Sensitivity** is usually defined as the 1 sigma RMS variation of noise in the data ( $\Delta S$ ) and so serves as a threshold for the detection of emission. For ALMA, basic sensitivity depends on (see *Useful Equations*, page 40): the number of antennas; receiver performance; atmospheric conditions (i.e., water vapor content and other atmospheric gases with strong spectral lines in the submillimeter (e.g. ozone), atmospheric turbulence, and target elevation); and, of course, integration time. These latter two effects are quantified by one parameter called “system temperature” ( $T_{\text{sys}}$ ). High  $T_{\text{sys}}$  values (in K) indicate low sensitivity and vice versa. Note that atmospheric opacity and stability are very frequency dependent (see Figure 4), and thus the ability to observe with any particular receiver will usually depend strongly on the weather conditions. These conditions include the water content of the atmosphere which attenuates astronomical emission, and atmospheric turbulence which results in phase instability. The magnitude of these problems generally increases with observing frequency.

### Learn More

Go to <http://casa.nrao.edu/> to learn more about using CASA to reduce ALMA data.

Two other aspects of the observational set-up strongly affect sensitivity: spectral resolution and angular resolution. Continuum intensities are often given in units of Janskys per beam where 1 Jansky (Jy) =  $10^{-26}$  W m<sup>-2</sup> Hz<sup>-1</sup>, while line intensities are often given in units of Kelvin (K). Converting from one unit to another requires knowledge about the angular resolution of the data, where the sensitivity in K is proportional to the sensitivity in Jy divided by the angular size of the beam (see p. 35). For a given  $\Delta S$ , the corresponding  $\Delta K$  increases with decreasing beam size; it is harder to detect extended line emission at high angular resolution. The quantity  $\Delta S$  itself varies as the inverse-square root of the product of total integration time and the total bandwidth of the observation. How data are weighted during imaging also affects sensitivity (see above). The total bandwidth of the observation is determined by the correlator settings and how many spectral channels, i.e, resolution elements, are averaged together. For continuum data, an effective bandwidth of up to 15 GHz (7.5 GHz in each polarization) can be used. Sensitivity also depends on the inverse square root of the number of observed polarizations; all ALMA bands have two polarization channels. There is an on-line sensitivity calculator available (see tools p. 39), as well as one built into the OT. One can also explore the required sensitivity in more detail using the *Sim-data* tool.

## Creating Images From Your Data

Once the data are taken, ALMA data will be reduced by the ALMA Division of Science Operations team (DSO) using a pipeline employing the Common Astronomy Software Applications (CASA) package. After the DSO has reduced the data and verified its quality, the raw and reduced data are shipped to the ARC data archives, where they are made available to the project teams. The project teams are provided with the raw data, the images (i.e. the pipeline-reduced calibrated data cube), and the scripts used by the pipeline (or, in Early Science, by DSO personnel).

Particularly during *Early Science*, but even during Full Operations, it may be that the baseline images will not meet the science requirements of the project team. The team will in this case want to optimize the reduction and imaging to get the best possible data for the project, most likely using CASA. In the following, we describe the basic concepts of reducing interferometer data. This process can be distilled down to two stages, calibration and imaging, and we discuss these below in turn.

**Calibration:** ALMA observing will be heavily constrained by weather conditions on the Llano de Chajnantor. Therefore, ALMA projects will be divided up into blocks of time (SBs) that can be executed dynamically by the on-site array operators when appropriate conditions are available. These blocks will contain observations of well-characterized, typically bright objects (calibrators) either before, during or

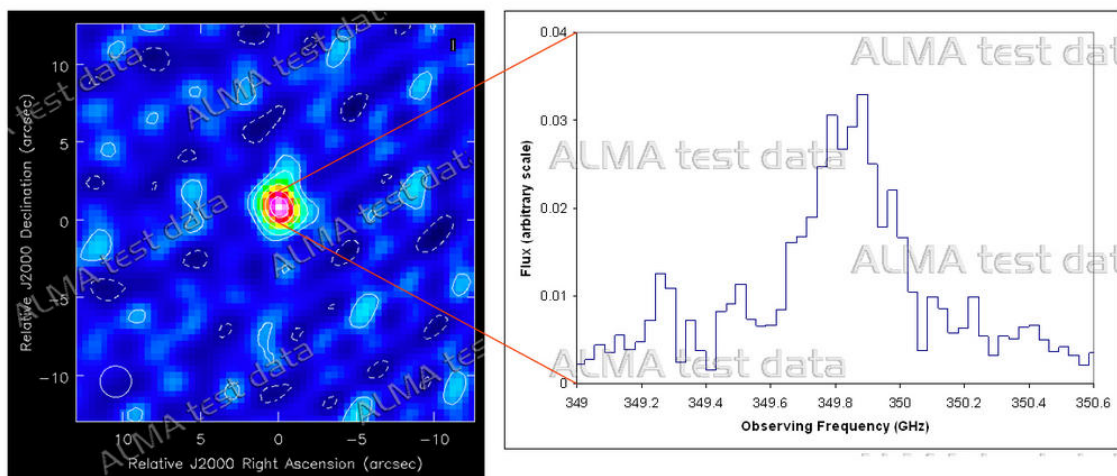

Figure 31: *ALMA Test Data* (Nov. 2010). As a test of ALMA's ability to observe broad spectral lines, the quasar BRI 0952-0115, which is at a redshift of  $z = 4.43$ , was observed. The object is unresolved on short baselines, but the 158  $\mu$ m line from ionized carbon is clearly detected in the spectrum, which is impressive given that this observation took only 1 hour in total. ©

after the target source observations are made. The calibrator data will be used to calibrate the target data during post processing.

Target data will require calibration of their amplitudes and phases, and for how these quantities vary with frequency. **Amplitude calibration** requires observations of at least one or two sources of known flux and angular extent. The brightness of these objects should vary only relatively slowly, so that an accurate estimate of their fluxes can be determined. Typically, very bright and compact radio sources, planets (Uranus), and even moons (Callisto) are used for this measurement. (Asteroids may be useful amplitude calibrators at high frequencies.) The observed data from these objects can be used to scale accurately the intensities recorded from the target. In addition, amplitude calibration devices (ACDs), which will be fitted to all antennas, will be used for relative calibration. **Bandpass (or passband) calibration**, sometimes called frequency calibration, also requires observations of bright sources with the same correlator setup as the target. If bright enough, variations of amplitude and phase with frequency will also be captured by these observations; typically amplitude calibrators are also used to gather these data. **Phase calibration** requires periodic observations of a moderately bright, very compact source at relatively small angular distance from the target. These data are used to correct for phase drifts that occur with time, e.g., small changes in the path length between antennas or through the atmosphere. The best sources for phase calibration are unresolved at the angular scales probed by the array; since such objects are point sources, their data have intrinsically zero phase (no emission at any angular offsets), and any phase changes recorded in the data are due only to changes in the system and/or atmosphere. The cadence at which the phase calibrator will be observed will depend on the stability of the atmosphere, the observational frequency, and the maximum baseline length. Atmospheric phase varies more rapidly at longer baselines, while at higher frequencies the variations have larger magnitude. The ALMA antennas will need to "fast-switch" between the target and phase calibrators every few seconds to capture these variations.

**Imaging:** ALMA datasets will be processed through a reduction pipeline so that project teams will be able to see preliminary results quickly. (During *Early Science*, while the pipeline is being developed, this processing will be done using a combination of the pipeline and by hand using CASA and other specially designed software, by members of the DSO and the ARCs.) There are many approaches to reducing and imaging interferometer data but these are the basics.

The heart of imaging is a **Fourier Transform** (FT) of the interferometer data (termed "**visibilities**") into images. The reduction process itself is threefold: first, the data are calibrated, then poor quality data must be removed from the ensemble before the FT, and finally, the image is made from the FT. Removing poor quality data ("**flagging**") is important because their inclusion in the data ensemble can have a large effect on the quality of the image made by the FT. For example, a high-amplitude spike in the visibilities will produce a high-amplitude ripple in the resulting image. Flagged, poor quality data can be ignored by the reduction software and are then effectively removed from the data en-

Figure 32: AOS technical building at 5000 m elevation. Chajnantor Volcano is in the background. © ALMA (ESO/NAOJ/NRAO)



semble. It is important to search for aberrant data to flag in both the calibrator and the target data sets; however, it is typically harder to see poor quality target data as targets are typically weaker than calibrators, and unusual variations of amplitude and phase are harder to identify. For smaller interferometers, data that need to be flagged are identified by visual inspection of amplitude and phase for antennas or antenna pairs, examined over a range of time or over a range of frequency. The sheer size of ALMA data products will make this kind of close inspection impractical, and tools are being developed to automate the process.

Data that have gone through flagging are ready to be imaged through an FT of the ensemble. Images need to be large enough to cover the field of view of ALMA, which varies with frequency, and sampled finely enough such that the structures observed at the high spatial resolution of the data can be accurately represented. Various spatial and spectral frequency weights can also be applied to the data during the FT to emphasize certain characteristics. For example, resolution and sensitivity can be traded-off by weighting the data in various ways, and "natural" weighting, where data are weighted relative to the number of spatial scales observed in the ensemble, typically provides the highest sensitivity. In addition, spectral channels can be averaged prior to the FT to improve sensitivity. The resulting image may include significant artifacts, depending on the complexity and brightness of the target region, and the amount and quality of data obtained; such images are sometimes called "dirty images". Since interferometers cannot measure all spatial frequencies, there will be gaps in the data ensemble that will translate into image artifacts after the FT. Even dirty images of point sources have these artifacts. The work-around to deal with these artifacts has been to model the data through various deconvolution techniques. A common algorithm is called "CLEAN". It works by iteratively subtracting low-amplitude versions of the "dirty beam" from the dirty image, starting at the brightest part of the dirty image and working down in intensity until only a residual image is left. The dirty beam is an image of a theoretical point source observed with the same  $uv$ -coverage as the actual data normalized to one. Cleaning typically continues until the flux density in the residual image is a small multiple of the noise in the dirty image but other thresholds are possible. The sky locations of the beam subtractions, called "clean components," are saved. The clean components are placed on a blank image, and these are all convolved with a Gaussian of size equal to that fit to the inner part of the dirty beam, i.e., a "clean beam". Finally, the residual image is added to the convolved component image to produce a "clean image". There are many approaches to deconvolving images; even Clean has many variations, but this is the basic idea. Of course, data will need to be deconvolved one spectral channel at a time, and this can be quite time consuming if the images are large or if there are many channels with emission, in the near future this process will be speed up through parallelization of the imaging algorithm(s).



Figure 33: The twelfth antenna reaches the AOS, 13 May 2011. (Photo courtesy of N. Mizuno)

## Interferometry Concepts for ALMA: A Glossary of Terms

**Array** An ensemble of antennas where signals measured by each antenna are cross-correlated with signals from all others to obtain data of high angular resolution. A homogenous array consists of antennas of the same diameter, like the 50 x 12 m antennas of ALMA. A heterogeneous array consists of antennas of different diameters, like the collection of 6 x 10.4 m antennas, 9 x 6.1 m antennas, and 8 x 3.5 m antennas that compose CARMA.

**Receiver** The instrument at each antenna in the array where astronomical signals are collected. The signals are combined with a highly accurate frequency signal at each antenna (the local oscillator) to produce a lower frequency (downconverted) signal that can be handled more effectively by array system electronics (e.g., amplification or transmission).

**Band** The emission frequency/wavelength range over which a given receiver is able to detect astronomical signals. For example, ALMA Band 3 is sensitive to astronomical emission over the range of 84-116 GHz (i.e., 2.6-3.4 mm).

**Bandwidth** The subrange of frequencies in a given Band over which data are obtained in a given observation. For example, a 7.5 GHz bandwidth can be sampled over the 84-116 GHz range of Band 3.

**Baseband** A baseband is a 2GHz wide portion of the available signal which is digitized at the antenna (effectively 1.875GHz because of anti-aliasing filters). Since the receivers are dual polarization, together their signals form a baseband pair. Four such 2GHz wide baseband pairs are delivered to the ALMA correlator (see Figure 33). The user-selected correlator configuration determines how many basebands are ultimately used, where they are placed in the available IF range, and which correlation products are produced (single, dual, or full polarization). The correlator configuration also defines a number of independent spectral windows within each baseband to produce spectra of the desired bandwidth and resolution.

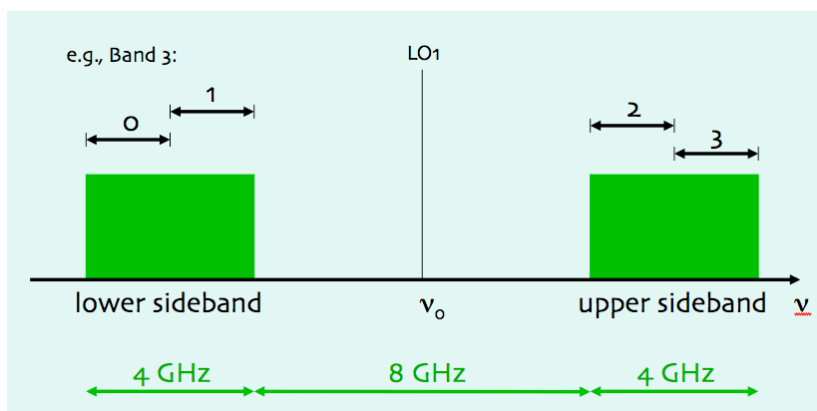

Figure 34: A graphical view of basebands and sidebands.

The correlator configuration also defines a number of independent spectral windows within each baseband to produce spectra of the desired bandwidth and resolution. The maximum available 8GHz bandwidth is thus achieved when the basebands are chosen to not overlap, and a correlator mode is chosen that processes the entire baseband.

**Correlator** A powerful computer which cross-correlates the amplified, down-converted signals from each antenna pair to produce the interference measurement (i.e, the “visibility”) from that pair.

**Sideband** At any given tuning, each receiver is sensitive to two separate ranges of sky frequency of equal width called sidebands (see Figure 33). The four available basebands can be placed in one sideband or distributed between the two sidebands; however, baseband numbers 0 and 1 must be placed in the same sideband as must basebands 2 and 3. In Bands 9 and 10, the receivers provide no inherent separation of the sidebands, so each baseband contains signal from both sidebands simultaneously. However, one can choose to reject one sideband from each baseband by selecting an appropriate observing mode to modulate the local oscillator. This technique can also be used in lower frequency bands to obtain even greater sideband separation than that provided by the receiver.

**Spectral Window** A spectral window is a frequency subrange of a baseband. The correlator configuration defines a number of independent spectral windows within each baseband to produce spectra of the desired bandwidth and resolution. At a given window frequency, the number and width of these channels determines the velocity range and resolution covered by each window. (For ALMA, the velocity resolution will be  $2 \times$  the channel spacing as the data will be Hanning smoothed by default.) Windows can be placed adjacent to one another to produce continuous coverage across the bandwidth or placed on individual interesting features within the band. In *Early Science*, only one spectral window per baseband will be available, and all of the spectral windows in all of the basebands must use the same bandwidth and resolution.

**Spatial Frequency** The inverse of an angular distance scale on the sky. As in Fourier analysis, any distribution of emission can be decomposed into information over a set of such spatial frequencies. Low spatial frequencies equate to large angular scales and high spatial frequencies equate to small angular scales. The  $uv$ -coverage is the sampling of the spatial frequencies by the interferometer.

**Visibility** An interferometric observation of a source made at a specific spatial frequency. The ensemble of (calibrated) visibilities is what is Fourier transformed to produce an image. Correspondingly, visibilities are complex numbers with amplitudes and phases that are related to the brightness and position of the emission relative to the position where the antennas are pointed. These amplitudes and phases need to be calibrated during observations by observing bright sources of known flux and position. Visibilities are sometimes referred to as "fringes." Each correlator channel produces its own visibilities. The ensemble of visibilities is the  $uv$ -coverage.

**Baseline** A pair of any two antennas in the array. The spatial frequency that a given baseline measures is related to the instantaneous foreshortened distance between the two antennas relative to the source and the wavelength of the observed emission. An array of  $N$  antennas will have  $N(N-1)/2$  baselines, so the 50-antenna 12 m antenna array will have 1225 baselines. In *Early Science*, 16 antennas provide 120 baselines.

**$uv$ -Coverage** The breadth of spatial frequencies sampled during an interferometric observation, so named because " $u$ " and " $v$ " are the spatial frequency counterparts to angular distances in Right Ascension (" $x$ ") and declination (" $y$ ") respectively. Since an interferometer can only sample a finite amount of spatial frequencies, the ability to reconstruct the true sky brightness from an interferometric observation increases with the  $uv$ -coverage. Images made from data of low  $uv$ -coverage ("snapshots") tend to have more secondary features due to aliasing, whereas images made from data of high  $uv$ -coverage ("tracks") tend to have less aliasing. The number of points in the  $uv$ -coverage goes as the number of baselines (i.e. as  $N(N-1)/2$  where  $N$  is the number of antennas), so will increase rapidly as more antennas are added to the array.

**Snapshot** A short-duration set of integrations of an astronomical source using all baselines. Since only a limited number of spatial frequencies is sampled (see  $uv$ -coverage above) the resulting image quality can be relatively poor, unless the number of baselines is large. (See Figure 11.)

**Track** A long-duration set of integrations of an astronomical source using all baselines. As the Earth rotates, the instantaneous foreshortened distances between antennas change. Obtaining integrations over different hour angles, i.e., "tracking the source," thus allows visibilities over a larger number of spatial frequencies to be measured ( $uv$ -coverage) and the resulting images more accurately reflect the actual emission distribution (assuming zero noise and perfect calibration).

**Nyquist Sampling** This is the minimum sampling interval needed to preserve the signal content without introducing aliasing errors. For ALMA, the Nyquist sampling rate for mosaicing fields is of order  $\lambda/2D$ , where  $\lambda$  is the observational wavelength and  $D$  is the antenna diameter.

**Zero-Spacing Flux (Total Power)** The large-scale emission which the array cannot detect. A pair of antennas cannot be physically separated by a distance less than the antenna diameter. Hence, there is a range of low spatial frequencies (from 0 to the lowest spatial frequency sampled by the array; see the “holes” in the center of the  $uv$ -coverage plots in figure 11) in any snapshot or track where emission has not been sampled, or has been “resolved out” by the array. Emission at large scales (low spatial frequencies) can be restored to images by combining array data with those from single-dish telescopes or an array of smaller antennas. For example, data from the 50-antenna extended array can be combined with data from the 12-antenna ACA or the 4-antenna TPA to address this problem. Note, however, that the ACA and TPA will not be available during *Early Science*.

**Primary Beam** The angular sensitivity pattern on the sky of each individual antenna in the array, i.e., the sensitivity to emission relatively close to their pointing direction. The primary beam is typically approximated by a Gaussian of FWHM equal to  $\sim 1.2(\lambda/D)$ , where  $\lambda$  is the observational wavelength and  $D$  is the antenna diameter. (Note that the OT defines the primary beam size to be  $= \lambda/D$ .) Parabolic radio antennas can have significant secondary angular sensitivities called sidelobes or the error beam, but these can be minimized by careful design and construction. The primary beam sets the FOV for an observation with the array, unless a larger mosaic is made. Limited mosaicing capability (maximum 50 pointings) will be offered during *Early Science*.

**Synthesized Beam** The effective angular resolving power provided by the ensemble of transformed visibilities given its range of spatial frequency coverage. The synthesized beam is analogous to the point spread function in an optical image. A typical observation will result in a synthesized beam with a primary feature that can be approximated by a Gaussian whose FWHM is typically given as the achieved high resolution of the image or cube. Incomplete spatial frequency coverage in the observation, however, results in aliasing, which can appear as significant secondary features to the synthesized beam. (Sometimes these are called synthesized beam sidelobes or dirty beams.)

**Dirty Image or Cube** The dirty image is produced by the appropriate Fourier transform of the measured visibilities. A single image is produced from a given window if all channels are combined (e.g., through averaging, summing, etc.). A cube is the ensemble of images, typically ordered in velocity or frequency, where visibilities from each channel have been Fourier transformed independently of those from other channels. The image or cube is considered “dirty” because the secondary sensitivity features of the synthesized beam have distorted the location and brightness of the true emission distribution, producing unphysical artifacts. Essentially, the dirty image is the convolution of the true brightness distribution with the synthesized or dirty beam.

**Clean Image or Cube** A deconvolved image (or cube of images), where the emission in each has been modeled in some manner so that distortions induced by secondary features to the synthesized beam are minimized. The optimal method of deconvolution depends on the science goals of the observation.

**Self-Calibration** Self-calibration is the use of a bright source to solve for the relative gains of the individual antennas in phase (and, optionally, amplitude). A minimum of three antennas is required to self-calibrate phase; four antennas are required to self-calibrate amplitude. In effect, the data are compared to an input model and the observed phases are corrected to reproduce the model as well as possible. For self-calibration to work, however, the data themselves must be fairly well characterized, i.e., they must have high S/N over a wide range of spatial frequencies.

If a science target is bright enough, it can be used for self-calibration. If not, another target must be observed for calibration which are then applied to the science target. Observations of the self-calibration target (a.k.a. a “phase calibrator”) must be interspersed with observations of the science target because the phase calibration varies over time. Angular proximity of the two targets is therefore desirable.

## A Few Useful Equations

**Converting Units:** In radio astronomy, one is often converting between different units of measurement and computing the required integration time for varying spectral resolutions. Here we provide a few important reference equations. (For further details, see "Tools of Radio Astronomy" by Rohlfs and Wilson.)

To convert between frequency and wavelength, a handy rule-of-thumb is to remember that the wavelength is  $\sim 1$  mm (to three decimal places) when the frequency is 300 GHz. Thus, to convert frequency (in GHz) to wavelength (in mm),

$$\lambda \text{ (mm)} = (300 \text{ GHz}) / (\nu \text{ GHz})$$

To achieve a particular velocity resolution  $\Delta v$  at a given observing frequency  $\nu$ , requires a frequency resolution  $\Delta \nu$  of

$$\Delta \nu = \left( \frac{\Delta v}{c} \right) \nu.$$

For example, a 1 km/s resolution at 300 GHz would require a frequency resolution of 1 MHz. Conversely a channel spacing of 0.0153 MHz (Correlator mode 12, see table page 9) would correspond to a velocity spacing of 0.0153 km/s at 300 GHz, or 0.0051 km/s at 900 GHz.

The conversion from brightness temperature  $T$  to flux  $S_\nu$  with synthesized beam solid angle  $\Omega_s$  is

$$S_\nu = \frac{2 \nu^2 k T}{c^2} \Omega_s.$$

An alternate formulae that is often useful is

$$\left( \frac{T}{1K} \right) = \left( \frac{S_\nu}{1 \text{ Jy beam}^{-1}} \right) \left[ 13.6 \left( \frac{300 \text{ GHz}}{\nu} \right)^2 \left( \frac{1''}{\theta_{max}} \right) \left( \frac{1''}{\theta_{min}} \right) \right]$$

Finally, the noise  $\Delta S_\nu$ , in an integration time  $\Delta t$ , varies with system temperature  $T_{sys}$ , frequency resolution  $\Delta \nu$ , number of antennas used  $N$ , diameter of the antennas  $D$ , and number of polarization measurements obtained  $n_p$ , in the following manner:

$$\Delta S \propto \frac{T_{sys}}{D^2 [n_p N(N-1) \Delta \nu \Delta t]^{1/2}} \text{ W m}^{-2} \text{ Hz}^{-1}.$$



## A Summary of “Learn More” Links

ALMA Science Portal / Resources for Scientists	<a href="http://almascience.org/">http://almascience.org/</a>
ALMA Explorer	<a href="http://www.nrao.edu/explorer/alma/">http://www.nrao.edu/explorer/alma/</a>
Common ALMA acronyms	<a href="http://www.almaobservatory.org/en/about-alma/acronyms">http://www.almaobservatory.org/en/about-alma/acronyms</a>
Joint ALMA Observatory	<a href="http://almaobservatory.org">http://almaobservatory.org</a>
NAASC	<a href="http://science.nrao.edu/facilities/alma/">http://science.nrao.edu/facilities/alma/</a>
EU-ARC	<a href="http://www.eso.org/sci/facilities/alma/arc/">http://www.eso.org/sci/facilities/alma/arc/</a>
EA-ARC	<a href="http://alma.mtk.nao.ac.jp/e/forresearchers/arc/">http://alma.mtk.nao.ac.jp/e/forresearchers/arc/</a>
EU-ARC Nodes	<a href="http://www.eso.org/sci/facilities/alma/arc/nodes/">http://www.eso.org/sci/facilities/alma/arc/nodes/</a>
Canadian ARC Node	<a href="http://almatelescope.ca/">http://almatelescope.ca/</a>
Taiwan ARC Node	<a href="http://alma.asiaa.sinica.edu.tw/">http://alma.asiaa.sinica.edu.tw/</a>
Intro to Interferometry	<a href="http://www.aoc.nrao.edu/events/synthesis/2010/lectures10.html">http://www.aoc.nrao.edu/events/synthesis/2010/lectures10.html</a>
Science & Software Tools	<a href="https://almascience.nrao.edu/document-and-tools/">https://almascience.nrao.edu/document-and-tools/</a>
ALMA Sensitivity Calculator	<a href="http://almascience.eso.org/call-for-proposals/sensitivity-calculator">http://almascience.eso.org/call-for-proposals/sensitivity-calculator</a>
Reducing Data with CASA	<a href="http://casa.nrao.edu/">http://casa.nrao.edu/</a>
Simulating ALMA Data	<a href="http://casaguides.nrao.edu/index.php?title=Main_Page#Simulating_Observations">http://casaguides.nrao.edu/index.php?title=Main_Page#Simulating_Observations</a>
Observation Support Tool	<a href="http://almaost.jb.man.ac.uk/">http://almaost.jb.man.ac.uk/</a>
<i>Splatalogue</i>	<a href="http://www.splatalogue.net/">http://www.splatalogue.net/</a>
ALMA Newsletters	<a href="http://www.almaobservatory.org/en/outreach/newsletter">http://www.almaobservatory.org/en/outreach/newsletter</a>
Press Releases	<a href="http://www.almaobservatory.org/en/press-room">http://www.almaobservatory.org/en/press-room</a>
ALMA Memos	<a href="http://www.alma.cl/almamemos/">http://www.alma.cl/almamemos/</a>



The Atacama Large Millimeter/submillimeter Array (ALMA), an international astronomy facility, is a partnership of Europe, North America and East Asia in cooperation with the Republic of Chile. ALMA is funded in Europe by the European Organization for Astronomical Research in the Southern Hemisphere (ESO), in North America by the U.S. National Science Foundation (NSF) in cooperation with the National Research Council of Canada (NRC) and the National Science Council of Taiwan (NSC) and in East Asia by the National Institutes of Natural Sciences (NINS) of Japan in cooperation with the Academia Sinica (AS) in Taiwan. ALMA construction and operations are led on behalf of Europe by ESO, on behalf of North America by the National Radio Astronomy Observatory (NRAO), which is managed by Associated Universities, Inc. (AUI) and on behalf of East Asia by the National Astronomical Observatory of Japan (NAOJ). The Joint ALMA Observatory (JAO) provides the unified leadership and management of the construction, commissioning and operation of ALMA.

